

Operating and Installation Manual

Barrett 4050 HF SDR Transceiver



BCM40500/30

© Barrett Communications

Head Office:

Barrett Communications Pty Ltd
47 Discovery Drive, Bibra Lake, WA 6163 Australia
Tel: +61 8 9434 1700 Fax: +61 8 9418 6757
Email: information@barrettcommunications.com.au

www.barrettcommunications.com.au

Contents

Introduction	12
Terms & Abbreviations	13
Exploring the 4050 HF Transceiver	15
Transceiver Front Panel	15
Keypad	16
Transceiver Front Panel Rear View	16
Transceiver Rear Panel	17
Switching the Transceiver On / Off	18
Switching the Transceiver On	18
Switching the Transceiver Off	19
Volume	19
Power Button Menus	20
Capture	20
Reboot / Shutdown	21
Resync	21
Locking and Unlocking the Screen	21
Display	22
Using the Microphone	24
Programming Functions	25
Program a New Channel from the Front Panel	25
Emergency Calls	26
Receiving an Emergency Call	27
Barrett Selective Calling System	28
Summary of Calling Systems	28
Selective Call - Selcall	29
Selcall Self IDs	29
Selcall Decode	29
Selcall Transmit	29
Selective Call - Telcall	29
Special Notes for the OEM Selective Call Protocol	30

BARRETT 4050 HF SDR TRANSCEIVER - OPERATING AND INSTALLATION MANUAL

Station ID Ranges	30
Call Key	31
Call Type	31
Beacon Call	32
Send a Beacon Call	32
Receive a Beacon Call	32
Selcall	33
Send a Selcall	33
Receiving a Selcall Directed to Your Transceiver	33
Receiving Allcalls, Group Calls and Sub-group Calls	34
Receiving an Allcall, Group Call or Sub-group Call	35
Telcall	35
Send a Telcall	35
Last Number Redial	37
Receive a Telcall	37
Pagecall	38
Send a Pagecall	38
Receive a Pagecall	39
GPS Req	40
GPS Pos	41
Hangup	42
Status	43
Requesting Another Station's Status	43
Secure	44
Contacts	45
Favourites	46
Call History	47
All	47
Received	47
Sent	48
Menus	49
Settings	49
Menu Map	50
General	52
Transceiver Name	52
Mic Up / Down Keys	53

BARRETT 4050 HF SDR TRANSCEIVER - OPERATING AND INSTALLATION MANUAL

Date and Time	53
Time Zone	54
BITE Test.....	54
Language.....	54
Security	55
Hopping PIN	55
Frequency Hop Rate.....	56
OEM Secure Type	56
OEM Secure Key.....	56
Secure Digital Voice Key.....	57
Secure Data Key	57
Secure Calls Hop Rate	58
Secure Call Code	58
TC2 Programming Mode.....	58
Labels.....	59
Add a Channel Label.....	59
Edit a Channel Label	60
Delete a Channel Label	60
Channels	60
Search For a Channel	61
Add a Channel	61
Number.....	62
Label	62
Rx Frequency	62
Tx Frequency	63
Mode	63
Tx Power.....	63
Selcall Format.....	64
ALE Channel	64
Antenna Socket.....	64
Save Channel	65
Edit a Channel	65
Delete a Channel.....	66
Contacts.....	66
Sort Contacts.....	66
Search Contacts.....	67
Add a Contact.....	67
First Name.....	68
Surname.....	68

BARRETT 4050 HF SDR TRANSCEIVER - OPERATING AND INSTALLATION MANUAL

ID Type	68
Four Digit	69
Six Digit	69
ARINC	69
ALE 2G Alias	70
ALE 3G Alias	70
Email Address.....	70
Phone Number	71
Favourite	71
Edit Contact.....	71
Delete Contact.....	72
Scan	72
Scan Rate	72
Dwell Time	73
Resume Time	73
Table Selection	73
Edit Scan Tables	74
Add a Scan Table	74
Scan Table Name.....	75
Antenna Socket	75
Scan Table Channel List.....	75
Save a Scan Table	76
Edit a Scan Table	76
Delete a Scan Table.....	76
Mute	77
Syllabic Sensitivity.....	77
Signal Strength Level	77
Selcall.....	78
Audio in Tx	78
Preamble Time	79
Default Int Selcall ID (4 Digits)	79
Default Int Selcall ID (6 Digits)	79
OEM Privacy Key	80
OEM Selcall ID (4 Digits)	80
OEM Selcall ID (6 Digits)	80
Selcall Networks.....	81
Add a Selcall Network	81
Selcall Network Alias.....	82
Selcall Format	82

BARRETT 4050 HF SDR TRANSCEIVER - OPERATING AND INSTALLATION MANUAL

4 Digit Selcall ID.....	82
6 Digit Selcall ID.....	83
Save a Selcall Network.....	83
Edit a Selcall Network.....	83
Delete a Selcall Network.....	84
GPS Broadcast Enable.....	84
Transceiver Lock.....	85
Audio.....	86
Beep Level.....	87
Alarm Audio Level.....	87
Ring Tones.....	88
Rx Configuration.....	88
Tx Configuration.....	89
Audio Bandwidth.....	89
Line Audio.....	90
Line Follows Digital Voice.....	90
Line Out Level.....	91
Line In Level.....	91
Audio Record.....	91
RF.....	92
Rx Preamp.....	92
Tx Over Beep.....	93
Transmit Timeout.....	93
Noise Blanker.....	94
Tx Power Level.....	94
AGC Hang.....	95
Broadcast Filter.....	95
Preselector.....	95
IO.....	96
RS232 Out.....	96
RS232 Baud Rate.....	97
EXT Alarm Type.....	97
Antenna 1 Type.....	98
Antenna 2 Type.....	99
ALE.....	100
ALE Set-up Overview.....	100
Combined ALE / Selective Call - Overview.....	101
ALE State Settings for 2G.....	101
ALE State.....	102

BARRETT 4050 HF SDR TRANSCEIVER - OPERATING AND INSTALLATION MANUAL

Preset Map	102
Response Control	103
Sounding Control	103
Sounding Address	104
LQA Exchange	104
LQA Averaging	105
LQA Decay Rate	105
Threshold Test	106
SINAD Threshold	106
BER Threshold	107
ALE State Settings for 3G	107
Voice Link Timeout	108
Data Link Timeout	108
LQA Averaging	108
LSU Mode	109
ALE 3G Channels	110
ALE 3G Addresses	110
Save the ALE Settings	110
System Info	111
System Status	111
Version Information	112
Transceiver Options	113
Enter Option PINs	113
4050 Serial Number	114
Call History	114
Export	114
Display	115
Level of Display Backlight	116
Backlight Timeout	116
Display Timeout Behaviour	116
Transmit Meter Mode	117
Receive Meter Mode	117
Temperature Units	117
Network	118
WiFi Operation Mode	118
WiFi Client	118
WiFi Access Point Mode	120
WiFi Access Point Setup	120
WPS Push Button	122

BARRETT 4050 HF SDR TRANSCEIVER - OPERATING AND INSTALLATION MANUAL

BoB.....	123
BoB Name.....	123
Network Settings.....	124
DHCP.....	124
IP Address.....	125
Network Mask.....	125
Default Gateway.....	125
Primary DNS.....	126
Secondary DNS.....	126
Network Status.....	127
Import / Update.....	127
Import Configuration.....	128
Program Firmware.....	129
Channels.....	130
Selecting a Channel.....	131
Search For a Channel.....	131
Hop.....	132
Selecting the Hop Band.....	132
Entering the Security Code.....	132
Security Codes and Bandwidths.....	132
To Enable Hopping Mode.....	133
To Disable Hopping Mode.....	133
Tune.....	134
Mode.....	134
NR.....	135
Scan.....	135
Selcall Scan.....	136
Signal Strength Scan (SSL Scan).....	136
Voice (Syllabic) Scan.....	136
Mute.....	137
Swipe Menu.....	138
Wireless Application.....	139
Downloading the Barrett SDR Remote Control Head Setup App.....	139
For Windows PCs.....	139
For iOS and Android Devices.....	140

BARRETT 4050 HF SDR TRANSCEIVER - OPERATING AND INSTALLATION MANUAL

Installing the Barrett SDR Remote Control Head Setup App	140
For Windows PCs.....	140
For iOS and Android Devices	141
Connecting the Wireless Device to the SDR	144
Preparing the SDR	144
Invoking the App.....	145
Exploring the App	146
Disconnecting the Wireless Device from the SDR	146
Cooling Fan	147
Installing the Cooling Fan	147
Connectors	148
Power Connector	148
GPS Connector	148
Aux Control Head / BoB Connector	149
Auxiliary Connector	149
ATU Connector	151
Microphone Connector	151
Control Head Rear Panel Connector	152
Cooling Fan Connector	152
Specifications	153
General	153
Receiver	154
Transmitter	155
Installation	156
Mobile Pack	156
Land Based Systems	159
Fixed Station Installations	160
Site Selection Recommendations	160
Power Supply	161
Voltage Drop	161
Protection Fuse	161
Antenna	162

BARRETT 4050 HF SDR TRANSCEIVER - OPERATING AND INSTALLATION MANUAL

912 Single Wire Broadband Dipoles	162
912 Multi wire Broadband Dipoles	165
913 Series Helical Dipoles	167
915 Wire Dipole	169
4017 Automatic Tuning Horizontal Dipole Antenna.....	171
Connection Details for a 4050 Transceiver and 4017 Automatic Tuning Horizontal Dipole Antenna	172
911 Automatic Antenna Tuner for Base Station Installations	173
Antenna	173
Transceiver and Tuner Mounting	173
Ground (Earth) System	174
Electrical Checkout.....	175
Connection Details for a 4050 Transceiver and 911 Automatic Antenna Tuner in a Base Station Configuration.....	176
4011 Automatic Antenna Tuner for Base Station Installations	177
Connection Details for a 4050 Transceiver and 4011 Automatic Antenna Tuner in a Base Station Configuration.....	178
Mobile Installations.....	180
Site Selection Recommendations	180
Power Wiring	181
Earthing.....	181
Antenna.....	182
Antenna Mounting	182
Antenna Feed Cables	182
Voltage Standing Wave Ratio (VSWR)	182
Noise Suppression	182
Interference Suppression Kit	183
General Noise Suppression Tips.....	185
2019 Automatic Tuning Mobile HF Antenna	186
Mounting the Barrett 2019 Automatic Tuning Mobile HF Antenna	186
Antenna Assembly.....	189
Mounting the Base Spring	189
Mounting the Whip Sections	189
Connection Details for a 4050 Transceiver with Mobile Pack and 2019 Automatic Tuning Mobile HF Antenna.....	191
Testing the Barrett 2019 Automatic Tuning Mobile HF Antenna	192
914 Series Manual Tap Whip Antenna	193
Installation	193
Operation Instructions.....	195

BARRETT 4050 HF SDR TRANSCEIVER - OPERATING AND INSTALLATION MANUAL

Connection Details for a 4050 Transceiver with Mobile Pack and 914 Manual Tapped Mobile Antenna	196
2018 Mobile Magnetic Loop Antenna	197
Connection Details for a 4050 Transceiver with Mobile Pack and a 2018 Mobile Magnetic Loop Antenna	197
Marine Installations.....	198
Antenna Selection	198
Antenna	199
Transceiver and Tuner Mounting	199
Ground (Earth) System	199
Corrosion	200
Electrical Checkout	200
Connection Details For a 4050 Transceiver and 911 Automatic Antenna Tuner in a Marine Installation	201
Overview of HF Operation.....	203
HF Propagation	203
Radio Wave Propagation.....	204
Factors Which Affect HF / SSB Communications	205
Frequency Selection.....	205
Time of Day.....	205
Weather Conditions	205
Man-made Electrical Interference.....	206
System Configuration and Installation	206
HF Communications Compared with VHF or UHF Short Distance Communications....	206
Compliance	207
FCC RF Exposure Compliance Statement	207
RF Exposure Warning.....	208
FCC Modulation Modes	208
Industry Canada Modulation Modes	208
Limited 3 Year Warranty Statement	209
Warranty Registration and Technical Support.....	210
Warranty Registration Contact Details	211
Index	212

Introduction

The Barrett 4050 Transceiver is an SDR based HF SSB Transceiver with a frequency range of 1.6 to 30 MHz. The Barrett 4050 is designed using the latest technology enabling a physically small package with a full feature complement.

Designed to operate in the most arduous environments, as encountered in off-road vehicles, vessels and aircraft, the Barrett 4050 will provide many years of efficient and trouble free service.

The Barrett 4050 supports features such as Selective Call (Selcall), direct dial telephone connection to base stations fitted with telephone interconnect systems (Telcall), GPS location, ALE (Automatic Link Establishment), frequency hopping, data transmission and remote diagnostics. These features make the Barrett 4050 HF Transceiver one of the most economical and versatile HF Transceiver available today.

The Barrett 4050 Transceiver caters for increased use of HF data transmission for Internet email access and point-to-point data applications, by providing a comprehensive data modem interface port, high speed transmit-to-receive switching, a high stability frequency standard and an efficient cooling system option.

The Barrett 4050 Transceiver can be operated in either a local (desktop) configuration for base station applications or, with the addition of an inexpensive mobile pack, in a remote control (trunk mount) configuration for mobile applications.

The Barrett 4050 Transceiver can be controlled from all major mobile and desktop platforms. The Barrett 4050 handset app supports iOS, Android and Windows devices for wireless voice and radio control. Full remote control is available via the Barrett 4050 Virtual Control Head app, providing unprecedented access to all transceiver functionality on Windows and OSX computers, iPad and Android tablets.

Operated from either 12 volt (13.8 V) DC or 24 V DC supplies, the transmitter is rated at 125 or 150 watt PEP respectively in voice mode and is protected from over-voltage or reverse-voltage application.

Up to 1000 channels (depending on the 4050 variant), are available to be field or workshop programmable. Auxiliary features such as Selcall, Telcall, scanning, mute status, alarm system etc. can be individually enabled or disabled for every channel as required to suit your operation.

Teamed with other matching Barrett products which include antennas, power supplies, vehicle tracking packages and HF modems, the Barrett 4050 HF Transceiver becomes a powerful tool, providing solutions to many long distance communication requirements.

Please note that this manual describes all the features of the 4050 HF SDR Transceiver and that some variants of the 4050 may not have all the features installed.

Terms & Abbreviations

Term / Abbreviation	Definition
ALE	Automatic Link Establishment
AM	Amplitude Modulation
ARINC	A set of standards as established by Aeronautical Radio, Incorporated (ARINC).
Call History	A list containing details of the last thirty calls received.
CCIR	One of many possible Selcall formats as defined by the Consultative Committee on International Radio (CCIR).
CW	Continuous Wave (used for Morse code)
dB	Decibels
dBm	Power ratio in decibels (dB) of the measured power referenced to one milliwatt (mW).
DSP	Digital Signal Processing
ESU	Encryption Synchronisation Unit
FHSS	Frequency Hopping Spread Spectrum
FSK	Frequency Shift Keying
GPS	Global Positioning System
HF	High Frequency
Identification Code	The unique reference identification (ID) of a Transceiver (not serial number).
IF	Intermediate Frequency
LCD	Liquid Crystal Display
LSB	Lower Sideband
LUF	Lowest Usable Frequency
MUF	Maximum Usable Frequency
OEM	Original Equipment Manufacturer
OTG	On-The-Go (USB)

Term / Abbreviation	Definition
PCB	Printed Circuit Board
PEP	Peak Envelope Power
PIN	Personal Identification Number
PSTN	Public Switched Telephone Network
PTT	Press-To-Talk button
Receive Only Channel	A channel that receives calls but does not transmit calls.
Revertive Tone / Signal	An acknowledgement signal automatically transmitted from a station receiving a Selcall.
RF	Radio Frequency
RFDS	Royal Flying Doctor Service (Selcall Format)
Rx	Receive
Scan Table	A list of channels used when scanning for incoming calls.
Selcall	Selective Calls
SCF	Suppressed Carrier Frequency
SSL	Signal Strength Level
Station ID	The ID of the station being called (the receiving station's Self ID).
Self ID	The programmed address identification number of a local station. (Used by other stations to call you.)
SMS	Short Message Service
SSB	Single Sideband (a transmission format)
Telcall	Telephone call using the Selective Call protocol.
Transmit Channel	A channel that allows you to receive and transmit calls.
Tx	Transmit
USB	Upper Sideband

Exploring the 4050 HF Transceiver



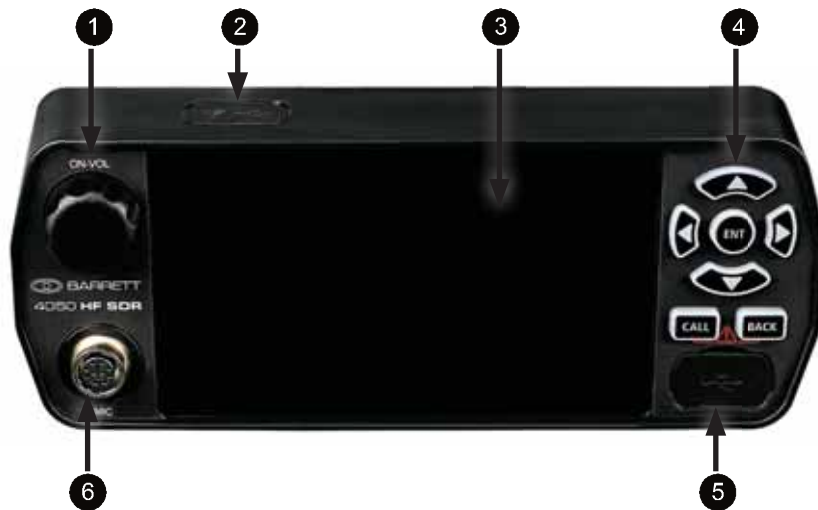



Transceiver Front Panel



- 1 Power button which combines switching the Transceiver on and off with adjusting the volume.
This will be represented as  throughout the manual.
- 2 USB / WiFi Socket
- 3 Touchscreen
- 4 Keypad
- 5 Mini USB Socket
- 6 Microphone socket

Keypad

There are seven keys on the keypad. Some keys have multiple functions assigned to them depending on when or how long the key is pressed.

Key	Function	Key	Function
	Channel Up / Scroll up		Enter / Set a menu item
	Channel Down / Scroll down		Make a call
	Scroll left and right		Clear / Back one step

Press the **CALL** and **BACK** buttons together to initiate an emergency call. See page 26 for further information.

Transceiver Front Panel Rear View

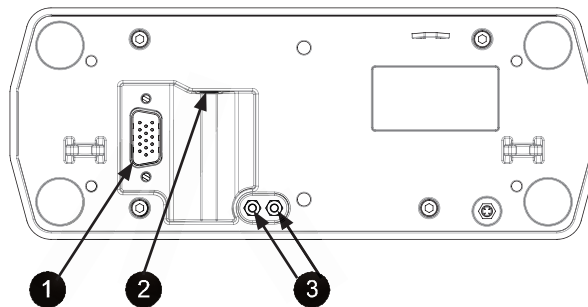

- 1 15-way Transceiver plug for remote front panel interface cable
- 2 Speaker jack
- 3 Stand-offs (supplied) to enable the front panel to be detached and an interface cable to be secured in position

The front panel may be detached from the Transceiver (for remote operation), by pulling the front panel away from the Transceiver. A six metre cable may be used to connect the front panel with the Transceiver's 15-way connector.

The speaker jack is used to connect an external loudspeaker (P/N BCA40015).

Transceiver Rear Panel



- 1 GND Use this stud to attach an earth connection. For example, vehicle chassis.
- 2 DC INPUT 12 - 24 V d.c. Power input for use with the 4022 power supply
- 3 GPS Input for GPS receiver (P/N BCA40009) for vehicle tracking / location applications.
- 4 ANT Main antenna socket
- 5 ATU Interface for Barrett automatic tuning mobile antenna and marine automatic antenna tuners.
- 6 AUXILIARY 25-way auxiliary interface
- 7 SPEAKER Output for loudspeaker (P/N BCA40015)
- 8 AUX CONTROL HEAD / BoB This can be used to attach a secondary control head (via a six metre cable) in addition to the front panel. This can also be used to attach a Break out Box. (see page 123)

Switching the Transceiver On / Off

Switching the Transceiver On

Momentarily press  to turn the Transceiver on.

A progress bar displays beneath the logo.



The Splash screen displays whilst the keypad illuminates white, green, red, and white.



The Home screen displays.



Switching the Transceiver Off

Press and hold  for three seconds to turn the Transceiver off.

The Transceiver returns to the Home screen and briefly displays a red confirmation message that the device is "Shutting Down".

A progress bar displays the status of the shutting down process.

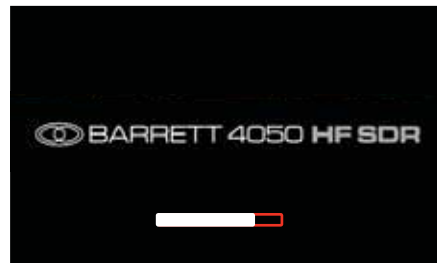

Volume

Rotate  clockwise to increase the volume and anti-clockwise to decrease.

The rectangular icon beneath the loudspeaker icon increases and decreases in length correlating with the volume.



Power Button Menus

With the Transceiver switched on, momentarily press  to display the Power Button menu.

Three options are available: Capture, Reboot / Shutdown, and Resync. These are described below.



Capture

Tap **Capture** from the Power Button menu to perform a screen capture.

A confirmation message displays and the screen capture is stored in the Transceiver.

To transfer the screen capture from the Transceiver to a PC, connect a cable with a mini USB plug into the Transceiver's front USB port and plug the other end with a standard USB plug into a PC's USB port.

From the Transceiver's home screen, select Menu > Export to display the Export screen. Select Export screenshots to save the screen captures from Transceiver to PC.



Reboot / Shutdown

Tap **Reboot / Shutdown** from the Power Button menu to switch the Transceiver off.

Tap and hold momentarily **Reboot / Shutdown** to reboot the Transceiver.

The Transceiver returns to the Home screen and briefly displays a red confirmation message that the device is "shutting down".



Resync

Tap **Resync** from the Power Button menu to resynchronise the Transceiver data with the control head.

Whilst resynchronising, the keypad illuminates green and the Busy status indicator animates.

Locking and Unlocking the Screen

Press and hold  for five seconds to lock the screen.

The following screen displays and the locked icon  is visible on the title bar.





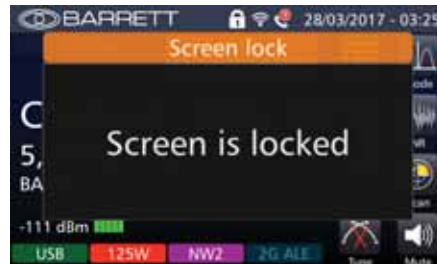



Similarly, with the screen locked,

press and hold  for five seconds to unlock the screen.



Display



- 1 Tune Status (page 134)
- 2 Digital Voice (page 138)
- 3 Status Indicators:
 -  Access Point (page 120)
 -  WiFi (page 118)
 -  Low Voltage
 -  Screen Lock (page 21)
 -  Busy
 -  GPS (page 148)
 -  USB (Import page 127, Export page 114)
 -  Call Received (page 31)
 -  BoB Active (page 123)

BARRETT 4050 HF SDR TRANSCEIVER - OPERATING AND INSTALLATION MANUAL

- 4 Date and Time (page 53)
- 5 Menus (page 49)
- 6 Antenna (page 64)
- 7 ALE (Channel) Status (page 60)
- 8 Selective Call Mode (page 64)
- 9 Transmit Power (page 63)
- 10 Mode (page 63)
- 11 Receive Strength Indicator
- 12 Channel Label (page 59)
- 13 Frequency (page 62)
- 14 Channel Number (page 62)
- 15 ALE (System) Status (page 102)

See page 115 for further information on Display Settings.

Using the Microphone

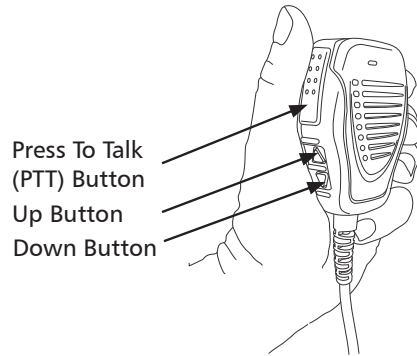

When Using the Microphone:

1. Press and hold the PTT (transmit) button only while talking
2. Position the microphone close to your mouth
3. Speak clearly
4. Use the word "over" to indicate that you have finished speaking, and then release the PTT (transmit) button.

Notes:

- *The Barrett 4050 has a transmit time-out facility. This facility (when programmed) allows the transmitter to be keyed in transmit mode with the PTT (transmit) switch for a set time period, after which the Transceiver switches to receive until the PTT (transmit button) is released and re-keyed. This facility prevents the transmitter transmitting for long periods of time if, for example, the microphone becomes jammed between seats in a vehicle causing the PTT (transmit) switch to be held down. Enabling, disabling and changing the time of the transmit timeout facility can be set either when programming the Transceiver or in the General Section of the Settings menu. See page 93.*
- *The microphone up / down buttons can be configured for channel change or volume control functions either when programming the Transceiver or in the General Section of the Settings menu. See page 53.*

Programming Functions

The Transceiver may be programmed in two ways:

- By direct key entry through the front panel. See page 49.

Note: This facility may not be available if the network administrator has locked it previously.

- By inserting a thumb drive containing the appropriate files into the Transceiver's USB socket. See page 127.

Program a New Channel from the Front Panel

Note: To program a channel from the front panel it is necessary to have this function enabled via the Barrett 4050 HF SDR Programming Software (P/N BCA40001).

Each channel requires the following parameters to be set:

- Channel Number
- Channel Label
- Rx Frequency
- Tx Frequency
- Channel Mode (USB, LSB, FSK, CW or AM)
- Channel Power (10, 30, 125 or 150 watt)
(Note: 150 W not available in Australia)
- Selcall Format (RFDS Alarm, OEM, CCIR, International or None)
- ALE Channel
- Antenna Select (Main or Auxiliary)

For information regarding adding a new channel, see page 61.

Emergency Calls

All Selcall emergency calls are transmitted by pressing the **CALL** and **BACK** buttons together for more than two seconds. The emergency call sequence commences when the buttons are released.



The action of the emergency call depends on how the Transceiver has been programmed. For example:

- Selective Call alarm that only transmits on the currently selected channel
Transmits the emergency Selcall sequence once on each press of the **CALL** and **BACK** buttons.
- Selective Call alarm that transmits and automatically changes to a selection of channels
Transmits the emergency Selcall sequence twice on each channel programmed as an emergency channel.
- Royal Flying Doctor Service (RFDS) alarm
Two-tone alarm 880 Hz + 1320 Hz continuous (Australian use only) – alerts the Royal Flying Doctor Service on RFDS channels.
The RFDS alarm will continue transmitting for ten seconds even if you have released the **CALL** and **BACK** buttons.

To cancel the RFDS alarm, press the **PTT** button or the **BACK** button.

*Note: A momentary press of the **CALL** and **BACK** buttons initiates an RFDS alarm test mode which emits the audio tones but does not transmit them.*

*Another momentary press of the **CALL** and **BACK** buttons or **PTT** cancels the RFDS alarm test mode.*

If a GPS receiver is fitted and enabled, the GPS position is also sent with the call.

Note: After the emergency call has been activated, there is no indication that an alarm is being sent for security purposes.

Receiving an Emergency Call

On receipt of an emergency Selcall, a distinctive audio alarm is emitted and the following message displayed.



If the Transceiver sending the emergency Selcall is fitted with a GPS receiver, the position will also be displayed.



Barrett Selective Calling System

There are several different types of Selective Calling Systems available in addition to simple point-to-point RF communications.

The calling systems available for the Transceiver are listed below:

- International - A four and six digit Selective Call system, fully interoperable with the UN format published in September 2004 and fully backwards compatible with all previous Barrett four and six digit Selcall protocols.
- OEM - A four and six digit Selective Call system compatible with other major HF manufacturers including those using encryption. Includes Selcall, Telcall, Beacon Call, Emergency call, Pagecall and GPS call.
- CCIR - A four digit Selective Call system as specified by CCIR-493.
- ALE FED-STD-188 / MIL-STD-188-141B (option) - MIL-STD Automatic Link Establishment system, refer to the Automatic Link Establishment (ALE) section on page 100.

Summary of Calling Systems

Call Type	International	OEM	CCIR
Emergency Call	Yes	Yes	No
Beacon Call	Yes	Yes	No*
Selcall	Yes	Yes	Yes
Telcall	Yes	Yes	Yes
Arinc Call	Yes	Yes	Yes
Page Call (SMS)	Yes	Yes	No
GPS Call (Data & Request)	Yes	Yes	No
Secure Call	Yes	No	No
Status Request Call	Yes	Yes	No
Transceiver Lock Call	Yes	No	No

* With Transceivers set to CCIR calling format, Beacon Call can be sent but will be decoded as a Selcall by other Transceivers.

Selective Call - Selcall

Selcall (selective calling) is a digital signalling system based on the standard CCIR-493 for use on HF networks. It is a type of squelch protocol used in radio communications systems, in which transmissions include a brief burst of sequential audio tones. Receivers that are set to respond to the transmitted tone sequence will open their squelch, while others will remain muted.

Selcall Self IDs

Each station in an HF network can be assigned up to 14 different Self IDs of which there can be a mixture of four or six digit IDs (identification). A station can be called using any of these Self IDs.

Selcall Decode

The Transceiver has the ability to decode both OEM and International Selcalls on any channel programmed as a Selcall channel. However, the call must be addressed to the relevant ID (OEM or International).

Calls for each format type will only be decoded if there is at least one Self ID of that format programmed into the Transceiver Self ID group.

Selcall Transmit

Selcall formats in transmit are channel specific. For example, only call types programmed for the channel are permitted. This means International and CCIR format calls can only be sent on channels that are programmed as International or CCIR Selcall channels. OEM calls can only be sent on channels that are programmed as OEM Selcall channels.

Selective Call - Telcall

Telcall uses this digital Selective Call system to send a telephone number from a station on an HF network to a base station equipped with a telephone interconnect unit to initiate phone calls onto the PSTN.

Note: For Selcall and Telcall functions to operate, the Transceiver must be fitted with the Selcall or Telcall option and the channels enabled for Selcall operation.

If Automatic Link establishment (ALE) is in use, refer to the Automatic Link Establishment (ALE) section on page 100.

Special Notes for the OEM Selective Call Protocol

Four and six digit OEM calls will only be decoded by other Barrett Transceivers fitted with the OEM Selcall protocol or other manufacturer's Transceivers that use encryption.

Four and six digit GPS and Status data calls use the OEM privacy key to encrypt the data. If this eight digit key has not been programmed by the Barrett 4050 HF SDR Programming Software (P/N BCA40001), a default privacy key of 99999999 is automatically used for transmission.

Six digit Page calls also use the privacy key but unlike the other calls, the user has the option to manually enable or disable the privacy key. When disabled, the data is sent as plain text.

Emergency GPS calls are automatically sent as plain text (four and six digit).

Station ID Ranges

The standard Selcall system accommodates four and six digit networks.

Station IDs range from 000000 to 999999 inclusive (the destination ID must be either four or six digits long).

Call Key

Use the **CALL** key to quickly invoke a call.

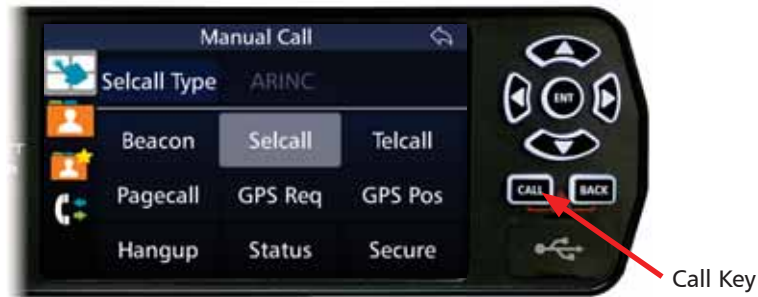

The **CALL** key is located in the lower left of the Transceiver's keypad, above the mini USB socket.

Press **CALL** and if necessary tap  to display the Manual Call screen.

The Call screen comprises two areas. The narrow left hand area has four menu options. The broader right hand area displays the screens for each of the menu options.

The Call menu options are: Call Type, Contacts, Favourites, and Call History. These options are described below.



Call Type

Press **CALL** and if necessary tap  to display the Manual Call screen.

From this screen choose the type of call to be made. The choices are: Beacon, Selcall, Telcall, Pagecall, GPS Req, GPS Pos, Hangup, Status and Secure. These are described below.



Beacon Call

A Beacon Call checks for the best channel to use between two stations. It allows the Operator to determine the signal quality between their station and the station they want to call on a particular channel, but without actually alerting the station they are doing so.

When a Beacon Call is sent to another station, and if the channel being used is open, the remote station sends back a distinctive four-tone revertive signal. The Operator can judge the quality of the channel for communications purposes by the strength and clarity of this distinctive tone. Using Beacon Calls on several available channels will determine which channel is best to use either subsequent Selcalls or Telcalls.

Note: both stations must be programmed for Selcall or Telcall operation.

Send a Beacon Call

Listen for traffic on your selected channel. If traffic is heard (channel is occupied), select another channel and try again.

Press **CALL** and if necessary tap  to display the Manual Call screen.

Tap **Beacon** to display the Selcall ID screen.

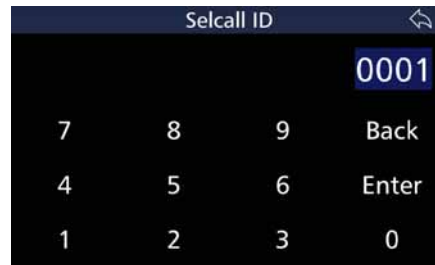

Use the keyboard to type the Selcall ID, then tap **Enter** or press **CALL** and wait for the Beacon Call to be sent. Listen for the distinctive four tone revertive signal from the station you have called. If the revertive call is not heard, or it was difficult to hear, try another channel and repeat the process until the best channel is found.

Receive a Beacon Call

When a Transceiver receives a beacon request call, it responds by transmitting the Beacon Call revertive tones. No indications occur on the Transceiver. Beacon Calls are not saved in the Selcall history buffer.

Selcall

Selcall is a digital signalling system based on standard CCIR-493 for use on HF networks. Each station in an HF network can be assigned Self IDs of which there can be a mixture of four or six digit IDs (identification). The station can be called using any of these Self IDs.

Send a Selcall

Select the channel you want to send the Selcall on. (Use a Beacon Call initially to select the best channel - see page 32.)

Listen for traffic on that channel. If traffic is not heard, press **CALL** and if necessary tap  to display the Manual Call screen.

Tap **Selcall** to display the Selcall ID screen.

Use the keyboard to type the Selcall ID, then tap **Enter** or press **CALL** and wait for the Selective Call to be sent.

Listen for revertive tone from the called station that indicates the call was successful.

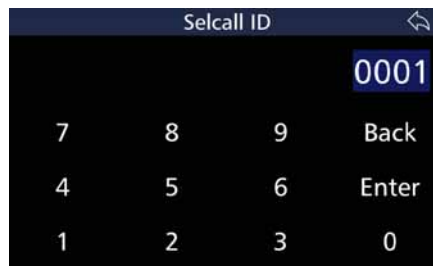

If the revertive tone is not heard or it was difficult to hear, try another channel and repeat the process until a good channel is found.

If a revertive tone is heard but you receive no verbal response from the station, it may be because the Operator is unavailable at the time.



Receiving a Selcall Directed to Your Transceiver

Note: To receive a Selcall your Transceiver must be programmed for Selective Call (Selcall) and where multiple channels are in use the scan function should be activated.

When you receive a Selcall, your station sends a reverberative tone (to alert the calling station that its call was received), an audible alarm sounds, the mute (squellch) (if selected) opens and the display shows who the call is from.



The audible alarm will sound for 60 seconds and then time out. To cancel the alarm before the time out period and to acknowledge the call, press the PTT button or tap **Ok**. When the audible alarm times out, the call received icon displays  and a periodic audio reminder is emitted.

For details of previously received Selcalls, press  and then tap  to display the Call History screen. Refer to the Call History section on page 47.

Receiving Allcalls, Group Calls and Sub-group Calls

Stations can send a Selective Call that will alert different groupings of mobiles as follows:

In four digit format

Allcall - A station sending X000 will be received by stations X000 - X999 (up to 890 stations*)

Group call - A station sending XX00 will be received by stations XX00 - XX99 (up to 89 stations*)

Sub-group call - A station sending XXX0 will be received by stations XXX0 - XXX9 (up to 9 stations*)

In six digit format

Allcall - A station sending XXX000 will be received by stations XXX000 - XXX999 (up to 890 stations*)

Group call - A station sending XXXX00 will be received by stations XXXX00 - XXXX99 (up to 89 stations*)



Sub-group call - A station sending XXXXX0 will be received by stations XXXXX0 - XXXXX9 (up to 9 stations*)

* If using the group call system, stations cannot be programmed to have Self IDs with last digits 000,00,0 as if you tried to call them a group call would occur.

Receiving an Allcall, Group Call or Sub-group Call

When you receive an Allcall, Group Call or Sub-group call, an audible alarm sounds, the mute (squench) (if selected) opens and the display shows the call type.

In all group calls the audible alarm will sound for 60 seconds and then time out. To cancel the alarm before the time out and to acknowledge the call, press the PTT button or tap **OK**. When the audible alarm times out, the call received envelope icon displays.

For details of previously received Selcalls, press  and then tap  to display the Call History screen. Refer to the Call History section on page 47.

Telcall



Telcall uses this digital Selective Call system to send a telephone number on an HF network. Telcalls are primarily used to send to stations equipped with a telephone interconnect unit to initiate phone calls onto the PSTN.

Note: For Selcall and Telcall functions to operate the Transceiver must be fitted with the Selcall or Telcall option and the channels enabled for Selcall operation.

If Automatic Link Establishment (ALE) is in use, refer to the ALE section on page 100.

Send a Telcall

Select the channel you want to send the Telcall on. (Use a Beacon Call initially to select the best channel - see page 32.)

Listen for traffic on that channel, if traffic is not heard, press  and if necessary tap  to display the Manual Call screen.

Tap **Telcall** to display the Selcall ID screen.

Type the Selcall ID, then tap **Enter** or press **CALL** to display the Telcall screen.

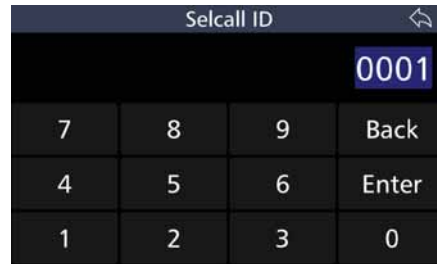

From the Telcall screen, tap either **Enter phone number** or **Select from contact**.



If Enter phone number was selected, the Phone Number screen displays.

Type the phone number using the keyboard and either press **ENT** or tap **Enter** to return to the home screen and send the Telcall.



The home screen momentarily displays the Telcall ID.



If Select from Contact was selected, the Contacts screen displays.
Tap the selected contact to return to the home screen and send the Telcall.



The home screen momentarily displays the Telcall ID.



Listen for reveritive tone from the called station that indicates the call is successful. If the reveritive tone is not heard, try another channel and repeat the process.

If the destination station is connected to a Telephone Interconnect, when the call is successful, wait for telephone connection to be made and then proceed with the call. When the call is complete, or if the line is busy, send a Hang-Up call (see page 42).

Last Number Redial

Press **CALL** four times and the last telephone number sent displays.

Press **CALL** once more and the Telcall sequence will be re-sent.

Receive a Telcall

Note: To receive a Telcall your Transceiver must be programmed with a Self ID and where multiple channels are in use the scan function should be activated.



When you receive a Telcall, your station sends a reveritive call (to alert the calling station that its call was received), an audible alarm sounds, the mute (squench) (if selected) opens and the Telcall screen displays.

The Telcall screen shows the Selcall ID and telephone number of the caller.
Tap **Stop** to stop the audible alarm but maintain the Telcall screen.
Tap **Close** To close the Telcall screen.



The audible alarm will sound for 60 seconds and then time out. To cancel the alarm before the time out period and to acknowledge the call, press the PTT button or tap either **Stop** or **Close** (described above). When the audible alarm times out, the call received Envelope icon displays and a periodic audio reminder is emitted.



After the timeout, the call received icon displays.

For details of previously received Telcalls, press  and then tap  to display the Call History screen. Refer to the Call History section on page 47.



Pagecall

Pagecall (SMS) allows messages of up to 32 characters in International format, or 64 characters in OEM format to be sent or received to and from other Transceivers with Pagecall facilities.

Send a Pagecall

Use  and  to select the channel you want to send the Pagecall on and listen for traffic on that channel.

Note: Use a Beacon Call initially to select the best channel - see page 32.

If traffic is not heard, press  and if necessary tap  to display the Manual Call screen.

Tap **Pagecall** to display the Selcall ID screen.

Use the keyboard to type the Selcall ID, then tap **Enter** or press **CALL** to display the PageCall Message screen.

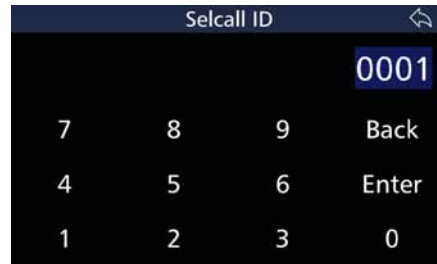

Type your message using the alpha numeric keys. The numbers in the parenthesis indicate how many characters you have used / total number of characters allowed.

Use up to 32 characters for an international Selcall and 64 for OEM.

Once the message is completed, tap **←** or press **CALL** to send.



Receive a Pagecall

When a Pagecall is received, an audible alarm sounds, any mute is disabled and the Pagecall screen displays

The Pagecall screen shows the Selcall ID and message.



Tap **Stop** to stop the audible alarm but maintain the Pagecall screen.

Tap **Close** To close the Pagecall screen.





The audible alarm will sound for 60 seconds and then time out. To cancel the alarm before the time out period, and to acknowledge the call press the PTT button or tap either **Stop** or **Close** (described above). When the audible alarm times out, the call received Envelope icon displays and a periodic audio reminder is emitted.

When the audible alarm times out, the call received Envelope icon displays.



For details of previously received Selcalls, press  and then tap  to display the Call History screen. Refer to the Call History section on page 47.

GPS Req

Use this option to request another station's GPS position.

Use  and  to select the channel you want to send the GPS request call on and listen for traffic on that channel.

Note: Use a Beacon Call initially to select the best channel - see page 32.

If traffic is not heard, press  and if necessary tap  to display the Manual Call screen.

Tap **GPS Req** to display the Selcall ID screen.

Use the keyboard to type the Selcall ID, then tap **Enter** or press .

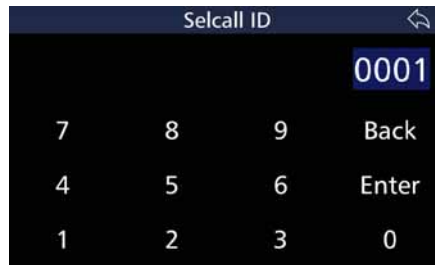

The station you called returns its position.

The GPS Data screen displays the caller's Selcall Alias (if available or alternatively the Selcall ID), and the caller's Latitude and Longitude position.

To stop the sounding alarm but maintain the GPS Data display, tap **Stop**. To remove the GPS Data display tap **Close**.





However, the following error messages may be displayed:

- **GPS Unresponsive at Remote Station**
The GPS unit is not providing data to the remote Transceiver.
- **GPS Not Fitted at Remote Station**
There is no GPS receiver fitted to the remote Transceiver.
- **No Response**
There was no response from the remote station.



GPS Pos

Use this option to send your GPS position to another station.

Note: The built-in GPS interface option must be fitted and the GPS receiver (P/N BCA40009) must be connected and receiving position information when using the GPS call option.

Use  and  to select the channel you want to send the GPS call on and listen for traffic on that channel.

Note: Use a Beacon Call initially to select the best channel - see page 32.

If traffic is not heard, press  and if necessary tap  to display the Manual Call screen.

Tap **GPS Pos** to display the Selcall ID screen.

Use the keyboard to type the Selcall ID, then tap Enter or press  to transmit your GPS position.

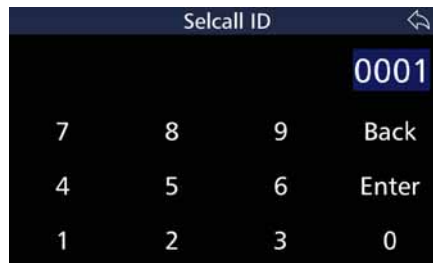

Wait for the revertive tone from the remote station to confirm the call was received. If revertive tone is not heard, repeat the process or change to another channel and repeat the process.

Note: If the display indicates that the GPS is unavailable, you cannot select the Selective Call function GPS data.

Hangup

When a call to a telephone interconnect base station has completed or a secure call link is complete, the Operator should 'hang-up' by sending a hang-up code to a telephone interconnect.

Note: If the hang up call is unsuccessful for any reason, the telephone interconnect will time out and hang-up automatically.

Press  and if necessary tap  to display the Manual Call screen.

Tap **Hangup** to display the Selcall ID screen.

Use the keyboard to type the Selcall ID, then tap **Enter** or press .

When the hang-up Selcall has completed transmitting, listen for hang-up revertive tone which confirms that the hang-up was successful.

When hanging up a telephone interconnect call, the hang-up process may be repeated until a revertive tone is heard.

If the hang-up call is unsuccessful when ending a secure call, only the Transceiver that sent the hang-up call will exit secure mode. Repeating the hang-up call will not hang-up the remote end.

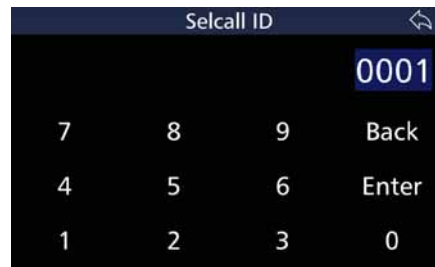



Status



A Status call allows the operational status parameters of any Barrett Transceiver fitted with Selcall to be accessed. This status is sent from the remote Transceiver as a Selcall with the status information embedded within the Selcall structure. Information retrieved for remote diagnosis of Transceiver performance includes:

- Selcall ID
- Receive state battery voltage
- Last transmit state battery voltage
- Signal strength indication of received status request Selcall
- Forward power output level
- VSWR of the antenna
- Temperature
- Selcall ID of the last radio called.

Requesting Another Station's Status

Use  and  to select the channel you want to send the Status request call on and listen for traffic on that channel.

Note: Use a Beacon Call initially to select the best channel - see page 32.

If traffic is not heard, press  and if necessary tap  to display the Manual Call screen.

Tap **Status** to display the Selcall ID screen.

Use the keyboard to type the Selcall ID, then tap **Enter** or press  to transmit the status request and wait for the remote station to return its status data.

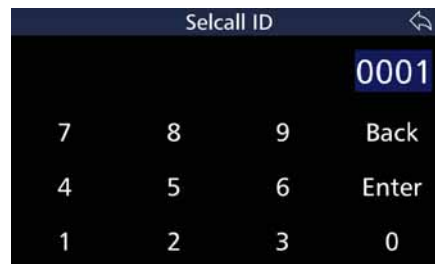



If a reply is not received, either repeat the process or change the channel and repeat the process.

Secure



Secure Calls can only be made on channels programmed with International Format Selcall.

A Person to Person(s) Secure Call allows a secure voice connection to be made between two or more stations.

Note: The 4 digit secure call code must be the same for both stations. See Secure Call Code on page 113.

Use  and  to select the channel you want to set the secure link to and listen for traffic on that channel.

Note: Use a Beacon Call initially to select the best channel - see page 32.

If traffic is not heard, press  and if necessary tap  to display the Manual Call screen.

Tap **Secure** to display the Selcall ID screen.

Use the keyboard to type the Selcall ID, then tap **Enter** or press  and wait for the Selective Call to be sent..

Note: To make a secure call to multiple stations, use a group call ID encompassing the required stations.

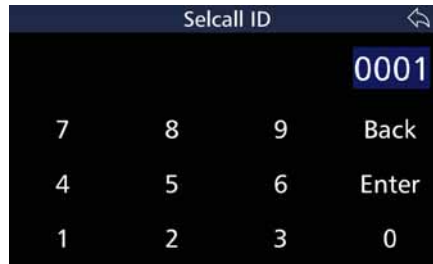

Listen for the secure call revertive tone from the called station which indicates the call was successful.

Note: The secure call revertive tone has a different sound to the revertive tones of the other call types.

If revertive tone is not heard or it was difficult to hear, try another channel and repeat the process until a good channel is found.

To exit out of secure call mode, press  or send a "Hangup" call.

Note: Revertive tones will not be heard if using a group call code to call multiple stations.

Secure mode is confirmed and indicated beneath the title bar.



Contacts



Selective call functions require Station IDs to be entered when making a call. Contacts allow frequently used Station IDs to be called easily.

This section describes how to use the Contact list, Favourites and Call History.

See page 67 for information on adding, editing and deleting contacts.

Press **CALL** and if necessary tap  to display the Contacts screen.

A list of contacts displays.

From the Contacts screen either:

- Select a contact from the Contact list. Scroll down the list to reveal more contacts by either swiping down on the touch screen or pressing  and then tapping the desired contact.
- Search for Contacts by tapping the Contacts field to reveal a keyboard. Tap the search criteria into the Contacts field.

Either tap  or press **ENT** or **CALL** to display the results of the search.



Favourites



Press **CALL** and if necessary tap  to display the Favourites screen.

A list of favourite contacts displays.

From the Favourites screen either:

- Select a contact from the favourites list. Scroll down the list to reveal more contacts by either swiping down on the touch screen or pressing  and then tapping the desired contact.
- Search for Contacts by tapping the Favourites field to reveal a keyboard. Tap the search criteria into the Favourites field.

Either tap  or press **ENT** or **CALL** to display the results of the search.

To add a contact, see page 67.



Call History

Whenever a Selcall, Telcall, Allcall, Group call, Sub-group call, Pagecall, Status-call, GPS or Emergency call is received or transmitted, its details are held in a first-in first-out call history buffer.

All received calls are stored in the Received tab.

All transmitted calls are stored in the Sent tab.

Each history buffer can store up to 100 entries.

Press  and if necessary tap  to display the Call History screen.

The Call History screen has three tabs: All, Received, and Sent. These are described below.

All

This tab displays a list of all calls sent and received.

The list also details the Selcall ID and the times of the calls.



Received

This tab lists all types of Selcalls that have been received, viewed and stored for future reference.

From the Call History screen, tap **Received** to display a list of all calls received.

The  icon indicates a missed call.



Sent

This tab lists all types of Selcalls that have been transmitted.

From the Call History screen, tap **Sent** to display a list of all calls sent.



Select the call displayed in any of the three Call History tabs to display the channel number, frequency, date and time.

Tap **Call** to proceed with a call to the selected number.

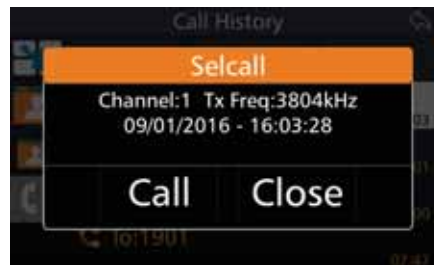

Menus

To navigate through the menus, either use swiping motions on the touch screen or use the keypad (described on page 16).

To return to a previous screen, you may also tap  located in the top right hand corner of each screen.

The Transceiver's home screen displays the following menus:

- Settings
- Channels
- Hop
- Tune
- Mode
- NR
- Scan
- Mute

These menus are described in the following sections.



Settings

Select the Settings menu to display the Settings screen which enables access to the following sub menus:

- General
- Security
- Labels
- Channels
- Contacts
- Scan
- Mute
- Selcall
- Audio
- RF
- IO
- ALE
- System Info
- Call History
- Export
- Display
- Network
- BoB (if connected)
- Import/Update

To reveal subsequent pages of sub menus, either swipe down on the touch screen or press .

These sub menus are described in the following sections.



Menu Map

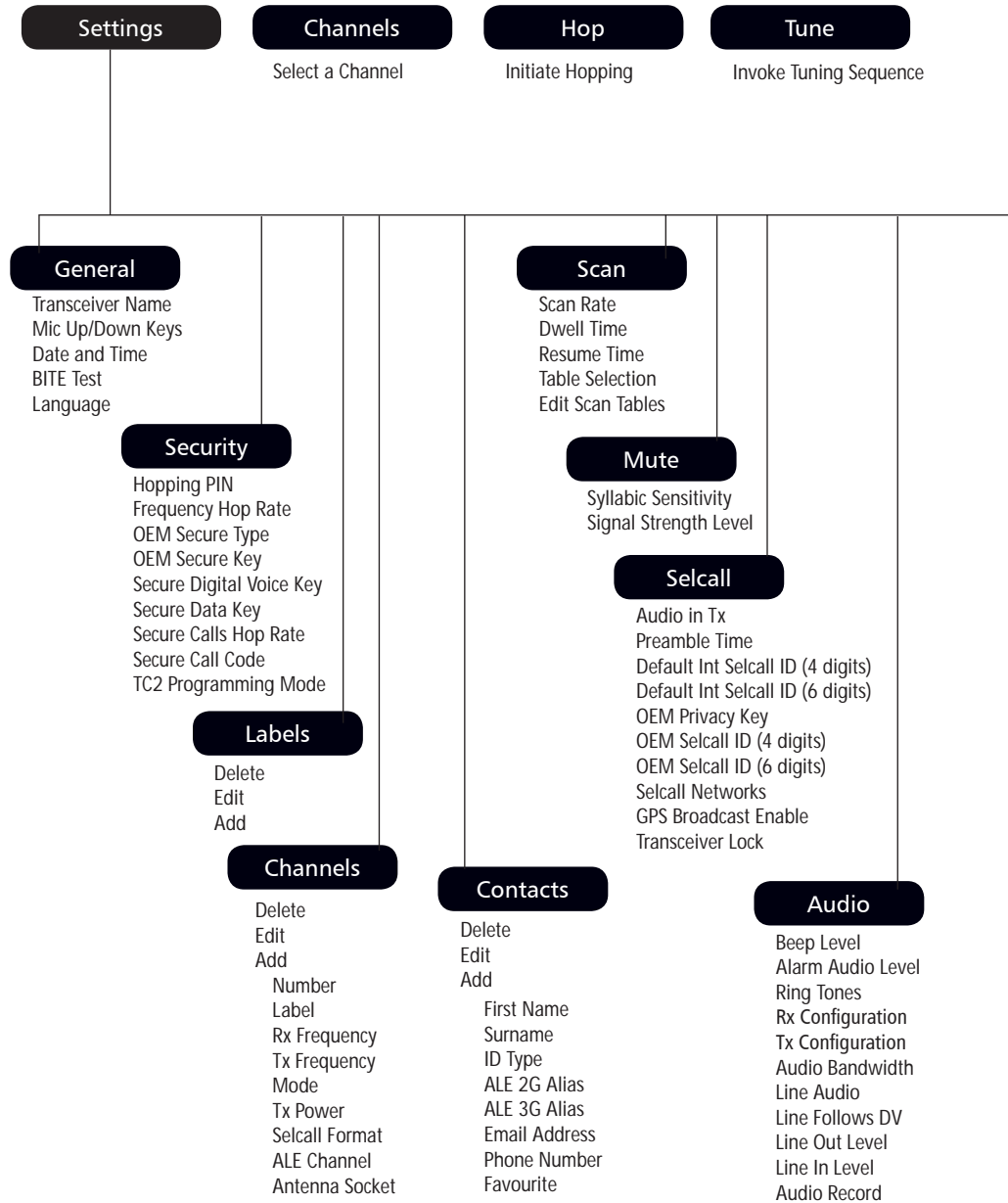

BARRETT 4050 HF SDR TRANSCEIVER - OPERATING AND INSTALLATION MANUAL

Mode	NR	Scan	Mute
USB	Off	Invoke Scanning	Audio Mute
LSB	Low		SSL Mute
FSK	Medium		Selcall Mute
CW	High		Mute Disabled
AM			

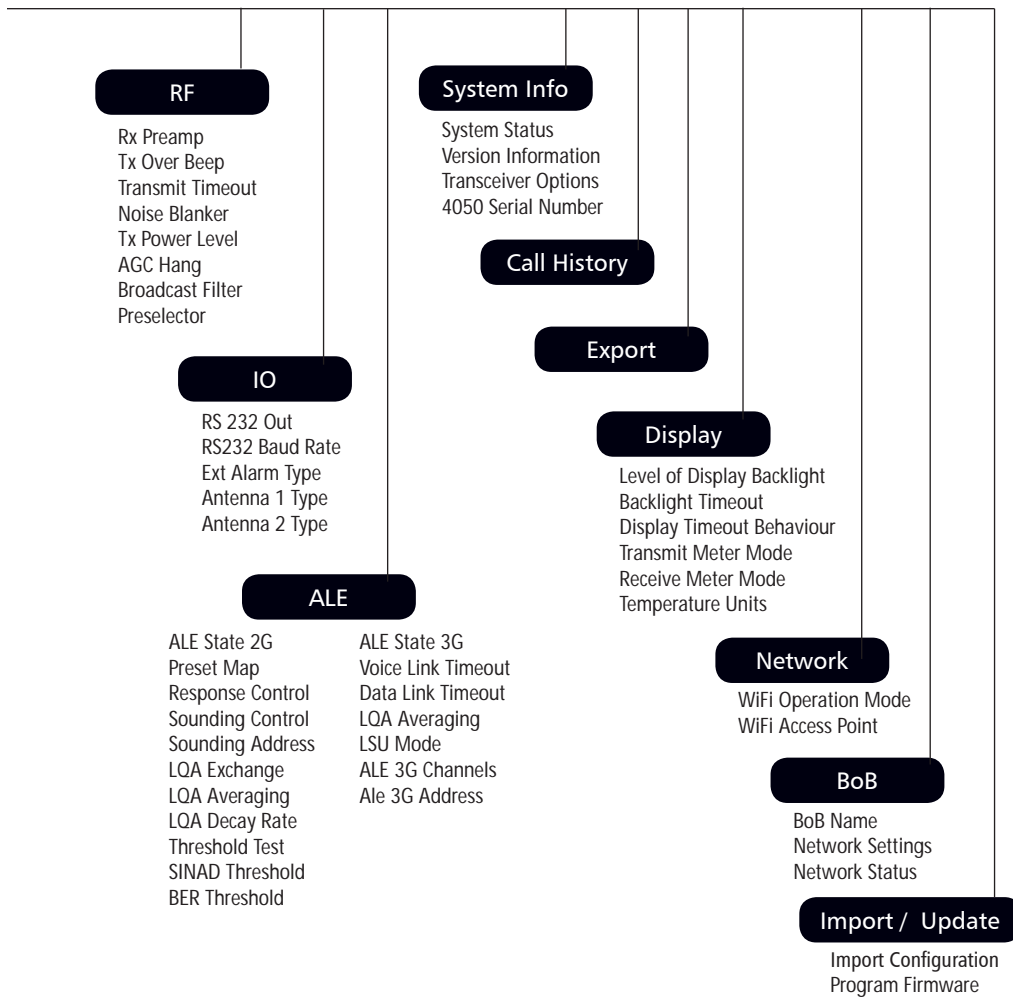

General

Select the General menu to display the General Configurations screen.

A list of items that may be configured is displayed. To reveal more items, either swipe down on the touch screen or press .

A brief description of each of the items which may be configured is described beneath the items.

The current status of each of the items is displayed to the right.

Each item on the list is described below.



Transceiver Name

Tap **Transceiver Name** from the General Configurations screen to display the SDR Name screen. The numbers in the parenthesis indicate how many characters you have used / total number of characters allowed.

Use the keyboard to type or edit the name of the SDR, then tap  to save.



Mic Up / Down Keys

The keys on the side of the microphone can be assigned to:

- Change channel (up / down)
- Change volume (up / down)
- Disabled.

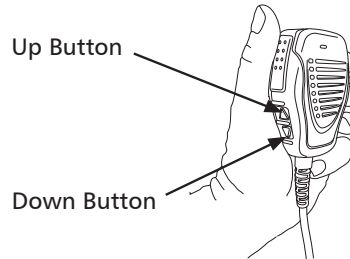

Tap **Mic Up/Down Keys** from the General Configurations screen to display the Mic Up/Down Keys screen.

Select either: Disabled, Channel, or Volume.

See page 24 for information on how to use the microphone.



Date and Time

Tap **Date and Time** from the General Configurations screen to display the Date & Time screen.

Set the Transceiver's date and time by swiping the touch screen vertically against the columns for hour, minute, day, month, and year.

When the highlighted figures are

correct, tap  to save.



Time Zone

Tap **Time Zone** from the Date & Time screen to display the Time Zone screen.

Scroll up or down to reveal more time zones. Tap or press  to select a desired time zone. The dates and times will automatically populate the fields in the Date and Time screen.



BITE Test

Tap BITE Test to perform internal testing. These tests essentially include all the hardware which make up the Transceiver.

The built in test is also automatically performed when the Transceiver is switched on.

Language

Tap **Language** from the General Configurations screen to display the Language screen.

Change the display language from the list shown.

To reveal more languages, swipe down on the touch screen or press



Security

This section is used to configure the security settings for the Transceiver.

Tap **Security** from the General Configurations screen to display the Security Settings screen.

A list of items that may be configured is displayed.

A brief description of each of the items is described beneath the items.

The current status of each of the items is displayed to the right.

Each item is described below.



Hopping PIN

Tap **Hopping PIN** from the Security Settings screen to display the Hopping PIN screen.

Type the Hopping PIN (maximum 8 characters) and then tap **Enter**.



Frequency Hop Rate

Frequency hopping can be used to limit performance degradation due to interference and to reduce the likelihood of interception. Frequency Hopping Spread Spectrum (FHSS) is a method of transmitting radio signals by rapidly switching a carrier among many frequency channels.

The Frequency Hop Rate is the rate at which the frequency hopping moves between transmission frequencies.

Tap **Frequency Hop Rate** from the Security Settings screen to display the Frequency Hop Rate screen.

Select either Standard or High.



OEM Secure Type

This displays whether a scrambler has been installed and the name of the scrambler. See below for further information.

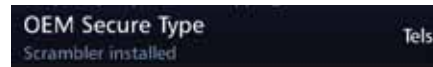

OEM Secure Key

The Audio Scrambler option is only available to Transceivers using the internally fitted audio scrambler accessory module that provides backwards compatibility to the 900 series audio inversion scrambler (P/N BCA20031), Telsy, or the Transcript scrambler. This option uses the OEM Scrambler encryption.

Tap **OEM Secure Key** from the Security Settings screen to display the OEM Secure Key screen.

Select between 1 and 16 for the Transcript scrambler or 1 and 32 for the audio inversion scrambler.

All stations using an Audio Scrambler require the same scrambler code to be entered in order to communicate.



Note: If using the internally fitted rolling code audio scrambler accessory module, the code must be set on the unit before installation using an external programmer.

To enable the scrambler, access the Swipe menu by swiping the home screen from left to right, then tap .

For more information, refer to the Swipe Menu on page 138.

Secure Digital Voice Key

The Secure Digital Voice Key is used for secure digital voice. Keys need to be entered into the TC2 module first using a third party TC2 tool.

Tap **Secure Digital Voice Key** from the Security Settings screen to display the Secure Digital Voice Key screen.

Select between 1 and 15.

The Transmit Transceiver must have the same number key as the Receive Transceiver in order to communicate.



Secure Data Key

The Secure Data Key is used to secure data. Keys need to be entered into the TC2 module first using a third party TC2 tool.

Tap **Secure Data Key** from the Security Settings screen to display the Secure Data Key screen.

Select either Disabled or a value between 1 and 15.

The Transmit Transceiver must have the same number key as the Receive Transceiver in order to communicate.



Secure Calls Hop Rate

The Secure Calls Hop Rate is the rate at which the secure call hopping moves between transmission frequencies. Unlike frequency hopping, it doesn't utilise GPS.

Tap **Secure Calls Hop Rate** from the Security Settings screen to display the Secure Calls Hop Rate screen. Select either Standard or High.



Secure Call Code

Tap **Secure Call Code** from the Security Settings screen to display the Secure Call Code screen.

Type the four digit PIN and tap **Enter**.

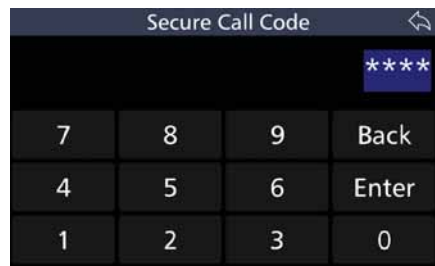

TC2 Programming Mode

If the Transceiver is fitted with a TC2 module, this option enables TC2 to be programmed.

Tap **TC2 Programming Mode** from the Security Settings screen to display the TC2 Programming Mode screen.

Select either Disabled or Enabled.

When enabled, the functionality of the Transceiver is disabled. After programming the TC2, reboot the Transceiver.



Labels





This section describes how to add, edit, or erase channel labels. Channel labels are used to indicate what a particular channel is used for. For example, UNHCR Geneva.

Note: Channel labels may be applied to channels when adding a channel. See page 62.

Tap **Labels** from the Settings screen to display the Channel Labels screen. A list of currently used channel labels display.





Add a Channel Label

To add a channel label, tap  to display the Add Label screen. Use the keyboard to type the name of the label, then tap  to save.



Edit a Channel Label

To edit a channel label from the Channel Labels' screen, select the label by using the  and  keys and either tap the label or press  from the keypad.

The Edit Label screen displays. The numbers in the parenthesis indicate how many characters you have used / total number of characters allowed.

Use the keyboard to edit the name of the label, then tap  to save.



Delete a Channel Label

To delete a channel label from the Channel Labels' screen, select the channel label you wish to delete, then tap and hold for three seconds. A confirmation message displays. Tap **Yes**.



Channels

Tap **Channels** from the Settings screen to display the Channels screen. A list of currently used channel displays. Each channel shows its channel number, frequency, and channel label.

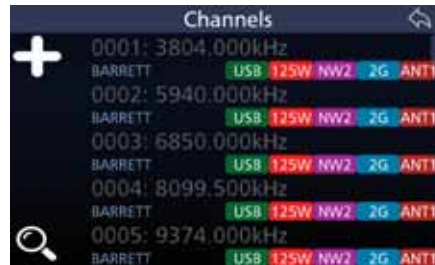

Search For a Channel

To search for a channel, tap  to display the Channel Number screen. Tap the appropriate digits for the search, then tap **Enter**.

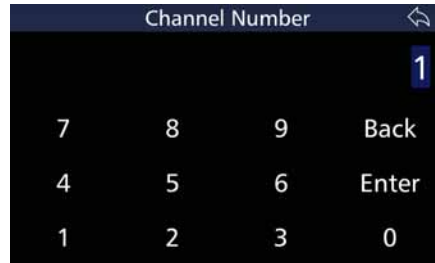

Add a Channel

To add a channel, tap  to display the Add Channel screen.

A list of attributes that may be configured is displayed. To reveal more attributes, either swipe down on the touch screen or press .

A brief description of each of the attributes which may be configured is described beneath the attribute.

The current status of each of the attributes is displayed to the right.

Each attribute on the list is described below.



Number

Tap **Number** from the Add Channel screen to display the Channel Number screen.

The default shows the next available channel number.

Tap **Back** to clear the Entry field. Tap the appropriate digits to represent the desired channel number, then tap **Enter**.

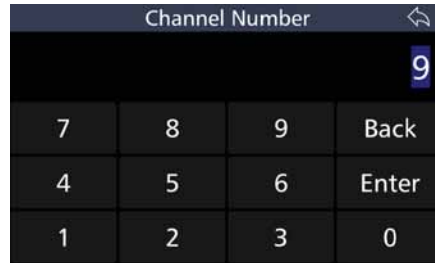

Label

Tap **Label** from the Add Channel screen to display the Label screen.

Select a label from the Label screen.

To reveal more items, either swipe down on the touch screen or press .

See page 59 for information on Channel labels.



Rx Frequency

Tap **Rx Frequency** from the Add Channel screen to display the Channel Receive Frequency screen.

Tap **Back** to clear the Entry field.

Tap the digits to represent the desired values (in kHz).

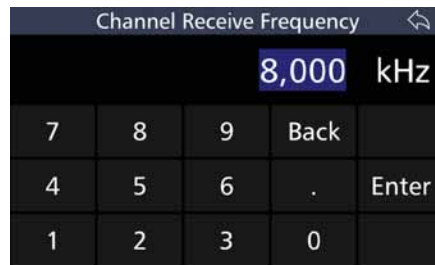

Tx Frequency

Tap **Tx Frequency** from the Add Channel screen to display the Channel Transmit Frequency screen.

Tap **Back** to clear the Entry field.

Tap the digits to represent the desired values (in kHz).

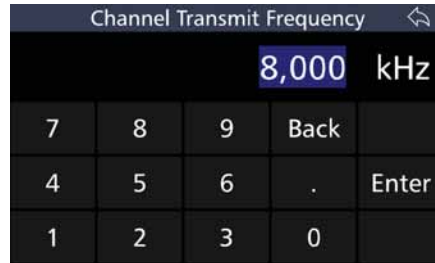

Mode

Tap **Mode** from the Add Channel screen to display the Mode screen.

To reveal more items, either swipe down on the touch screen or press .

The choices are: Upper Sideband, Lower Sideband, Frequency Shift Keying, Continuous Wave (Morse code), and Amplitude Modulation.



Tx Power

Tap **Tx Power** from the Add Channel screen to display the Tx Power screen.

Select either: 10 W, 30 W, or 125 W.



Selcall Format

Tap **Selcall Format** from the Add Channel screen to display the Selcall Format screen.

To reveal more items, either swipe down on the touch screen or press .

Select either: None, INT, CCIR, OEM, RFDS, NW1, NW2, NW3, NW4, or NW5.

Refer to page 28 for further information on Selcall systems.



ALE Channel

Displays the ALE status of a channel: either: True, False, or Disabled.

Antenna Socket

Tap **Antenna Socket** from the Add Channel screen to display the Antenna Socket screen.

Select either: Antenna 1 or Antenna 2.

Note: As there is only one antenna socket on the Transceiver, this option only applies if you are using a Break out box.





Save Channel

After configuring the above attributes, tap  to add the channel. A confirmation message displays. Tap **Yes**.



Edit a Channel

To edit a channel, select the desired channel by using the  and  keys from the Channel screen (page 60) and either tap the channel or press  from the keypad. The Channel Information screen displays. Edit the fields as described above (Add a Channel).

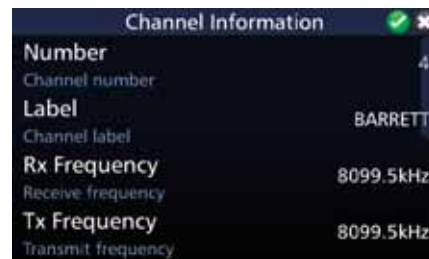

After the channel's attributes have been edited, a confirmation message displays.

Tap **Yes**.

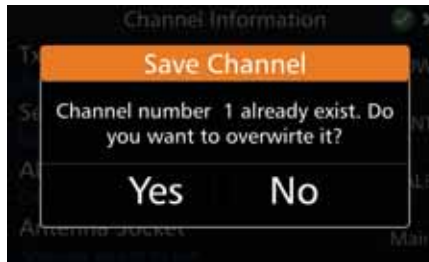

Delete a Channel

To delete a channel, tap and hold for three seconds the channel you wish to delete. A confirmation message displays.

Tap **Yes**.



Contacts



Tap **Contacts** from the Settings screen to display the Contacts screen.

A list of contacts display. Each contact shows their Selcall ID and telephone number.



Sort Contacts

There are two sort icons.

- To sort by first name, tap .
- To sort by last name, tap .



Only one sort icon will display at any time.

If the list has already been sorted by first name, the Sort By Last Name icon will display.

If the list has already been sorted by last name, the Sort By First Name icon will display.

Search Contacts

To search contacts, tap the Contacts field to reveal a keyboard. Tap the search criteria into the Contacts field.

Either tap  or press  or  to display the results of the search.



Add a Contact

To add a contact, tap . The Add Contact screen displays.

A list of items that may be configured is displayed. To reveal more items, either swipe down on the touch screen or press .

The current status of each of the items is displayed to the right.

Each item on the list is described below.



First Name

Tap **First Name** from the Add Contact screen to display the First Name screen.

Tap the appropriate characters from the keyboard into the First Name field. The numbers in the parenthesis indicate how many characters you have used / total number of characters allowed.

Tap  to save and return to the Add Contact screen.



Surname

Tap **Surname** from the Add Contact screen to display the Surname screen.

Tap the appropriate characters from the keyboard into the Surname field. The numbers in the parenthesis indicate how many characters you have used / total number of characters

allowed. Tap  to save and return to the Add Contact screen.



ID Type

Tap **ID Type** from the Add Contact screen to display the ID Type screen.

Select either: Four digit, six digit, or ARINC. These options are described below.

Select Unassigned if there is no Id type to be associated with the contact.



Four Digit

Tap **Four Digit** from the Id Type screen to display the Selcall ID screen.
 Tap the appropriate characters from the keyboard into the Selcall ID field.
 Tap **Enter** to save and return to the Add Contact screen.

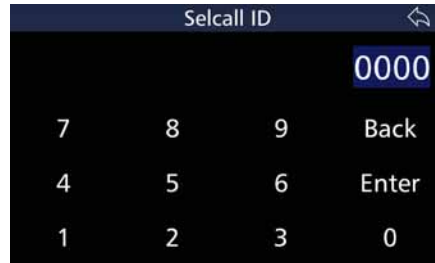

Six Digit

Tap **Six Digit** from the Id Type screen to display the Selcall ID screen.
 Tap the appropriate characters from the keyboard into the Selcall ID field.
 Tap **Enter** to save and return to the Add Contact screen.

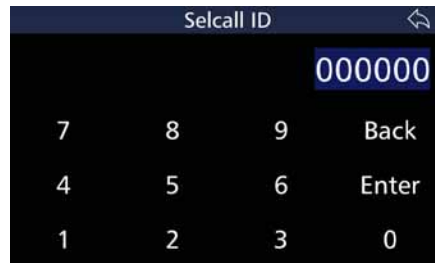

ARINC

Tap **ARINC** from the Id Type screen to display the ARINC Call screen.
 Tap the appropriate characters from the keyboard into the ARINC Call field. The numbers in the parenthesis indicate how many characters you have used / total number of characters allowed.

Tap  to save and return to the Add Contact screen.

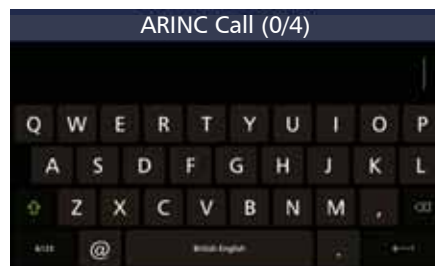

ALE 2G Alias

Tap **ALE 2G Alias** from the Add Contact screen to display the ALE Addresses screen. Tap the appropriate characters from the keyboard into the ALE Address ID field.

Tap  to save and return to the Add Contact screen.



ALE 3G Alias

Tap **ALE 3G Alias** from the Add Contact screen to display the ALE Addresses screen. Tap the appropriate characters from the keyboard into the ALE Address ID field.

Tap  to save and return to the Add Contact screen.



Email Address

Tap **Email Address** from the Add Contact screen to display the Email Address screen.

Tap the appropriate characters from the keyboard into the Email Address field. The numbers in the parenthesis indicate how many characters you have used / total number of characters allowed.

Tap  to save and return to the Add Contact screen.



Phone Number

Tap **Phone Number** from the Add Contact screen to display the Phone Number screen. Tap the appropriate characters from the keyboard into the Phone Number field.

Tap  to save and return to the Add Contact screen.





Favourite

Tap **Favourite** from the Add Contact screen to display the Favourite screen.

Select **Yes** to add to the favourite contacts.



Edit Contact

To edit contact details, select the desired contact by using the  and  keys and either tap the contact or press  from the keypad. The Edit Contact screen displays. Edit the details as described above (for Add Contact).



Delete Contact

Select the contact to be deleted, then tap and hold for three seconds. A confirmation message displays. Tap **Yes**.

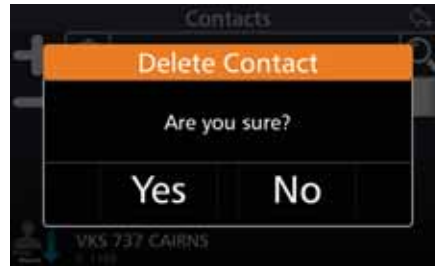

Scan



Tap **Scan** from the Settings screen to display the Scan screen.

A list of items that may be configured is displayed. To reveal more items, either swipe down on the touch screen or press .

Each item is described below.



Scan Rate

Select the scan rate applicable to non-Selcall scan channels.

Tap **Scan Rate** from the Scan screen to display the Scan Rate screen.

To reveal more items, either swipe down on the touch screen or press .

Select either: 300, 500, 700, 1000, 1500, 2000, or 5000 ms.



Dwell Time

Select the length of time the Transceiver dwells (waits) on a channel after scan has been stopped by signal strength level (if signal strength level mute is set) or voice activity (if audio mute is set).

Tap **Dwell Time** from the Scan screen to display the Dwell Time screen.

To reveal more items, either swipe down on the touch screen or press



Select between one and ten seconds.



Resume Time

Set the time period after which the Transceiver will automatically resume scanning from the last operation. For example, after a key press or PTT.

Tap **Resume Time** from the Scan screen to display the Resume Time screen.

To reveal more items, either swipe down on the touch screen or press



Select either: Off, 1, 2, 3, 5, 10, 15, 20, or 30 minutes.

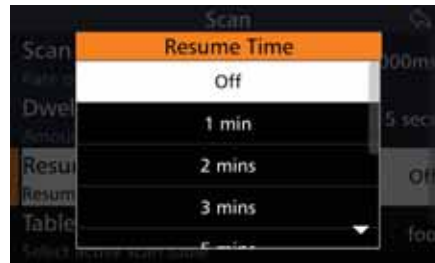



Table Selection

Select the Scan Table to be used when the Transceiver is put into scan mode, or if enabled, when scan resume occurs.

There can be up to eight Scan Tables.

Note: When scrolling through the Scan Tables to make a selection, only Scan Tables with channels entered will display. If none of the Scan tables have any channel entries, the message "All Scan Tables Empty" displays.

Tap **Table Selection** from the Scan screen to display the Table Selection screen.

To reveal more items, either swipe down on the touch screen or press .

The example shows four tables to select from. Each table revealing the name of the table and the respective number of channels.



Edit Scan Tables

Note: All channels are displayed in numerical order within the scan table with respect to the entry number. There are a maximum of 30 entries in each table.

Tap **Edit Scan Tables** from the Scan screen to display the Selcall Scan Tables screen.

The example shows two scan tables which may be edited. Each table reveals the name of the table, the antenna, the number of channels in the table and the channel numbers.

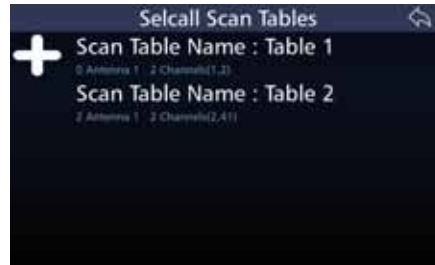

Add a Scan Table

To add a Scan Table, tap . The Scan Table screen displays.

A list of items that may be configured is displayed.

A brief description of each of the items which may be configured is described beneath the items.

The current status of each of the items is displayed to the right.

Each item on the list is described below.



Scan Table Name

Tap **Scan Table Name** from the Scan Table screen to display the Scan Table Name screen.

The default name is alias. Overtyping the default name by tapping the appropriate characters from the keyboard into the Scan Table Name field.

Tap  to save and return to the Scan Table screen.



Antenna Socket

Tap **Antenna Socket** from the Scan Table screen to display the Antenna Socket screen.

Select either Antenna 1 or Antenna 2.

Note: As there is only one antenna socket on the Transceiver, this option only applies if you are using a Break out box.



Scan Table Channel List

Tap **Scan Table Channel List** from the Scan Table screen to display the Scan Channel Selection screen.

Tap the checkboxes adjacent to the channels you wish to choose and

then tap .



Save a Scan Table

After configuring the above items, tap  to add the table. A confirmation message displays. Tap **Yes**.



Edit a Scan Table

To edit a table, select the desired table and either tap the table or press  from the keypad.

The Scan Table screen displays. Edit the details as described above (for Add a Scan Table).

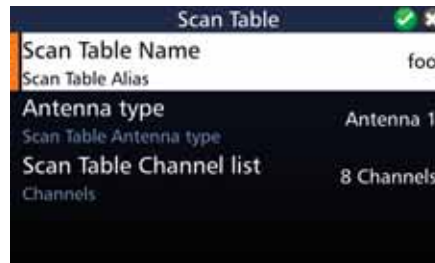

Delete a Scan Table

Select the table to be deleted, then tap and hold for three seconds. A confirmation message displays. Tap **Yes**.



Mute



Tap **Mute** from the Settings screen to display the Mute screen.

A list of items that may be configured is displayed.

Each item is described below.



Syllabic Sensitivity

Set the sensitivity or 'hardness' of the syllabic mute (squelch).

Tap **Syllabic Sensitivity** from the Mute screen to display the Syllabic Sensitivity screen.

Select either: Low, Medium, or High sensitivity to voice activity on a channel.



Signal Strength Level

Select the level at which the Signal Strength Level (SSL) mute (squelch) opens.

Tap **Signal Strength Level** from the Mute screen to display the Signal Strength Level screen.

Select either: Low, Medium, or High.

When set to low, the mute will open on a relatively low level of received signal. When set to high, the mute will open on a relatively high level of received signal.



After configuring the above items, tap  or press **BACK** to save the settings and return to the Mute screen.

Selcall

Tap **Selcall** from the Settings screen to display the Selcall screen.

A list of items that may be configured is displayed.

A brief description of each of the items is described beneath the items.

The current status of each of the items is displayed to the right.

To reveal more items, either swipe down on the touch screen or press .

Each item is described below.



Audio in Tx

Tap **Audio in Tx** from the Selcall screen to display the Audio in Tx screen.

Select either: Off, Low, or High.



Preamble Time

Tap **Preamble Time** from the Selcall screen to display the Preamble Time screen.

Select between one and ten seconds.

To reveal more items, either swipe down on the touch screen or press



Default Int Selcall ID (4 Digits)

Tap **Default Int Selcall ID** from the Selcall screen to display the Network Selcall ID screen.

The default in this example is four digits 0000. Overtyping the default by tapping the appropriate characters from the keyboard into the Network Selcall ID field.

Tap **Enter** to save and return to the Selcall screen.



Default Int Selcall ID (6 Digits)

Tap **Default Int Selcall ID** from the Selcall screen to display the Network Selcall ID screen.

The default in this example is six digits 000000. Overtyping the default by tapping the appropriate characters from the keyboard into the Network Selcall ID field.

Tap **Enter** to save and return to the Selcall screen.



OEM Privacy Key

Tap **OEM Privacy Key** from the Selcall screen to display the OEM Privacy Key screen.
Select either On or Off.



OEM Selcall ID (4 Digits)

Tap **OEM Selcall ID** from the Selcall screen to display the Network Selcall ID screen.

The default in this example is six digits 0000. Overtyping the default by tapping the appropriate characters from the keyboard into the Network Selcall ID field.

Tap **Enter** to save and return to the Selcall screen.

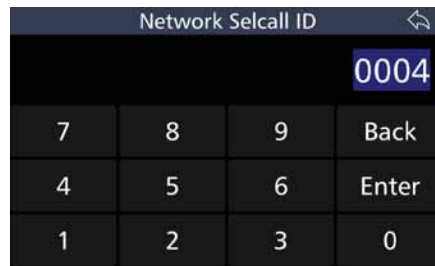

OEM Selcall ID (6 Digits)

Tap **OEM Selcall ID** from the Selcall screen to display the Network Selcall ID screen.

The default in this example is six digits 000000. Overtyping the default by tapping the appropriate characters from the keyboard into the Network Selcall ID field.

Tap **Enter** to save and return to the Selcall screen.



Selcall Networks

Tap **Selcall Networks** from the Selcall screen to display the Selcall Network screen.

The example shows two Selcall Networks (maximum five) which may be edited. Each Selcall Network revealing the name of the network alias, the Selcall format, the four and six digit Selcall ID.



Add a Selcall Network

To add a Selcall Network, tap . The Selcall Network screen displays.

A list of items that may be configured is displayed.

A brief description of each of the items is described beneath the items.

The current status of each of the items is displayed to the right.

Each item on the list is described below.

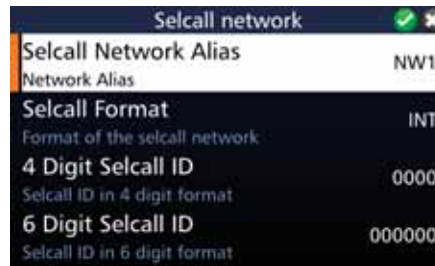

Selcall Network Alias

Tap **Selcall Network Alias** from the Selcall Network screen to display the Selcall Network Alias screen. The numbers in the parenthesis indicate how many characters you have used / total number of characters allowed.

The default alias is NW1. Overtyping the default alias by tapping the appropriate characters from the keyboard into the Selcall Network Alias

field. Tap  to save and return to the Selcall Network screen.



Selcall Format

Tap **Selcall Format** from the Selcall Network screen to display the Selcall Format screen.

Select either: None, INT, CCIR, OEM, or RFDS.



4 Digit Selcall ID

Tap **4 Digit Selcall ID** from the Selcall Network screen to display the Selcall ID screen.

The default ID is 0000. Overtyping the default ID by tapping the appropriate characters from the keyboard into the Selcall ID field.

Tap **Enter** to save and return to the Selcall Network screen.

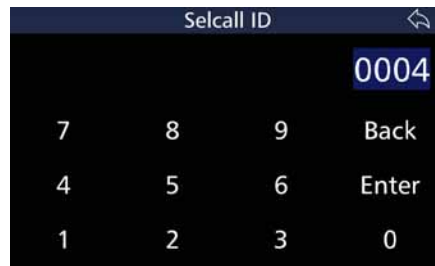

6 Digit Selcall ID

Tap **6 Digit Selcall ID** from the Selcall Network screen to display the Selcall ID screen.

The default ID is 000000. Overtyping the default ID by tapping the appropriate characters from the keyboard into the Selcall ID field.

Tap **Enter** to save and return to the Selcall Network screen.

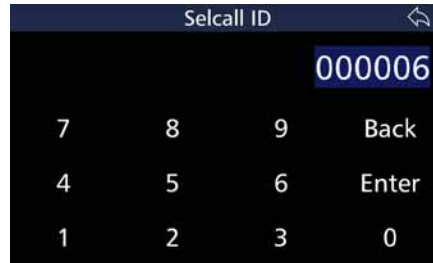

Save a Selcall Network

After configuring the above items, tap  to add the Selcall Network. A confirmation message displays. Tap **Yes**.



Edit a Selcall Network

To edit a Selcall Network, select the desired network and either tap the network or press  from the keypad.

The Selcall Network screen displays. Edit the details as described above (for Add a Selcall Network).



Delete a Selcall Network

Select the Selcall Network to be deleted, then tap and hold for three seconds.

A confirmation message displays.

Tap **Yes**.



GPS Broadcast Enable

Tap **GPS Broadcast Enable** from the Selcall screen to display the GPS Broadcast Enable screen.

Select either Disabled or Enabled.

This setting will either prevent or allow the periodic broadcasting of the Transceiver's GPS position.

Timings for the GPS broadcast are set via the Barrett 4050 HF SDR Programming software (P/N BCA40001).



Transceiver Lock

To lock a remote Transceiver with a PIN, tap **Transceiver Lock** from the Selcall screen to display the Selcall ID screen.

Use the keyboard to type the PIN, then tap **Enter**.

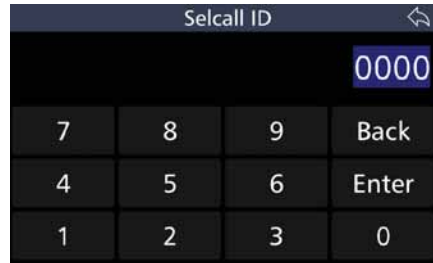

The Transceiver Lock PIN screen displays.

Use the keyboard to type the PIN again, then tap **Enter**.



The Transceiver Lock screen displays.

Tap **Yes** to send a Transceiver lock on the respective channel with the PIN.

Tap **No** to abort.



Audio

Tap **Audio** from the Settings screen to display the Audio screen.

A list of items that may be configured is displayed.

A brief description of each of the items is described beneath the items.

The current status of each of the items is displayed to the right.

To reveal more items, either swipe down on the touch screen or press .

Each item is described below.



Beep Level

This section is used to set the annunciation beep volume levels. These are the various tones associated with key presses. Annunciation beeps can be disabled for covert operations. For other operations these are set purely for Operator feedback.

Tap **Beep Level** from the Audio screen to display the Beep Level screen.

Select either: Off, Low, or High.



Alarm Audio Level

Tap **Alarm Audio Level** from the Audio screen to display the Alarm Audio Level screen.

Select either: Mute, Low, Med, or High.



Ring Tones

Tap **Ring Tones** from the Audio screen to display the Ring Tones screen.

Select from a series of different sounding tones: Ringtone 1 through to Ringtone 7.

These ring tones are used when receiving alarms, Selcall etc.

To reveal more items, either swipe down on the touch screen or press



Rx Configuration

This option sets where the unprocessed receiver audio in the Transceiver is sourced.

Normally, this is set to internal in which case the Transceiver's receiver provides the unprocessed audio.

When used with a remote receiver in split site operations, the audio path can be set to external. In this case, unprocessed received audio from the remote site can be input into the auxiliary sockets 600 ohm balanced audio port.

Tap **Rx Configuration** from the Audio screen to display the Rx Configuration screen.

Select either: Internal Audio, or External Audio.



Tx Configuration

This option sets where the transmitter audio in the Transceiver is sourced.

Normally, this is set to local in which case the Transceiver's microphone provides the transmitter audio.

When used with a remote site operation, the path can be set to remote. In this case, the transmit audio is input into the auxiliary sockets 600 ohm balanced audio port.

Tap **Tx Configuration** from the Audio screen to display the Tx Configuration screen.

Select either: Local or Remote.



Audio Bandwidth

This section allows the audio bandwidth to be tailored to an Operator's comfort requirements.

Tap **Audio Bandwidth** from the Audio screen to display the Audio Bandwidth screen.

Select either:

- 300 Hz - 2700 Hz,
- 300 Hz - 3000 Hz,
- 300 Hz - 3200 Hz, or
- 300 Hz - 3400 kHz.



Line Audio

This option sets the muting condition of the 600 ohm balanced audio line output on the rear auxiliary connector.

The line output can be set to Unmuted or Follows Mute. When set to Follows Mute, the line output is muted in the same manner as the speaker output and follows the mute condition currently in use. The line output is usually set to Unmuted when using data modems.

Tap **Line Audio** from the Audio screen to display the Line Audio screen.

Select either: Unmuted, or Follows Mute.

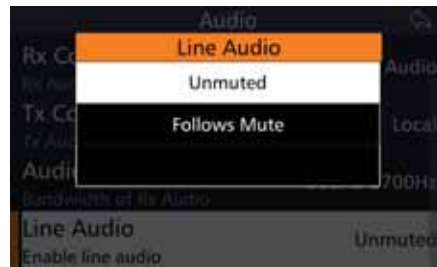

Line Follows Digital Voice

Line Follows Digital Voice may be used for example with a 2060 Telephone Interconnect. The 2060 PTTs the radio through the line and transmits the voice. From the drop-down menu select either Off or On.

Tap **Line Follows Digital Voice** from the Audio screen to display the Line Follows Digital Voice screen.

Select either: Disabled or Enabled.



Line Out Level

This setting adjusts the output level of the auxiliary 600 ohm balanced audio output port.

Tap **Line Out Level** from the Audio screen to display the Line Out Level screen.

Select either: +12, +9, +6, +3, 0, -3, -6, -9, -12 dBm.

To reveal more items, either swipe down on the touch screen or press



Line In Level

This setting adjusts the input level sensitivity of the auxiliary 600 ohm balanced audio input.

Tap **Line In Level** from the Audio screen to display the Line In Level screen.

Select either: +9, +6, +3, 0, -3, -6, -9, -12, -18, -24 dBm.

To reveal more items, either swipe down on the touch screen or press



Audio Record

This option is used to monitor conversations. It utilises the line audio to listen to the received and transmitted audio. Connect another device to record the conversation.

Tap **Audio Record** from the Audio screen to display the Audio Record screen.

Select either: Disabled or Enabled.



RF 

Tap **RF** from the Settings screen to display the RF screen.

A list of items that may be configured displays.

A brief description of each of the items is described beneath the items.

The current status of each of the items is displayed to the right.

To reveal more items, either swipe down on the touch screen or press .

Each item is described below.



Rx Preamp

Enables or disables the RF pre-amplifier. The pre-amplifier provides an additional receiver gain of 5 dB. Generally, the RF pre-amplifier is switched off when an automatic mobile antenna is in use as these antennas have a built-in RF pre-amplifier.

Tap **Rx Preamp** from the RF screen to display the Rx Preamp screen.

Select either: Disabled or Enabled.



Tx Over Beep

When this option is selected, the Transceiver transmits a short tone after the PTT button is released. The tone provides an audible indication to the Operator at the remote station that the local station has stopped transmitting.

Tap **Tx Over Beep** from the RF screen to display the Tx Over Beep screen.

Select either Disabled or Enabled.



Transmit Timeout

When this feature is enabled, the Transceiver will stop transmitting if the PTT button is held on for more than the allowed time limit. For example, if the microphone is inadvertently jammed under a seat. Releasing the PTT button will re-enable transmission.

Tap **Transmit Timeout** from the RF screen to display the Transmit Timeout screen.

Set the maximum transmit time to either one, two, or three minutes. Alternatively, this transmit timeout can be disabled.



Noise Blanker

This setting allows the predictive noise blanker to be switched on or off. The noise blanker is useful to reduce the interference caused within vehicles with petrol engines.

Note: The noise blanker will not be effective in situations where for example, external power line noise is blanketing the receiver.

Tap **Noise Blanker** from the RF screen to display the Noise Blanker screen.

Select either: Off or On.

Note: In certain situations noise blankers can cause intermodulation in receivers. In these cases the noise blanker should be disabled.

The noise blanker can also be controlled from the Swipe menu (see page 138).



Tx Power Level

This section sets the RF power output of the Transceiver.

Tap **Tx Power Level** from the RF screen to display the Tx Power Level screen.

Select either: 10 W, 30 W, 125 W, or 150 W.



AGC Hang

This section allows the AGC configuration of the receiver to be set to either Hang AGC or Hang Off. The selection depends on the receiver environment and should be set for optimum receiver performance. In the presence of high static and sporadic noise, the function of the hang AGC may result in gaps in the received signal due to the slow AGC recovery.

Tap **AGC Hang** from the RF screen to display the AGC Hang screen.

Select either: Hang Off or Hang AGC.



Broadcast Filter

Tap **Broadcast Filter** from the RF screen to display the Broadcast Filter screen.

With the Broadcast Filter enabled, strong broadcast signals below 1.6 MHz will be filtered out.

Select either: Disabled or Enabled.



Preselector

Tap **Preselector** from the RF screen to display the Preselector screen.

Select either: None or Sunair F9800.

The Preselector can be used for selectable gain and automatic RF overload protection.



IO

Tap **IO** from the Settings screen to display the IO screen.

A list of items that may be configured is displayed.

Note: Antenna 2 Type is only available if connected to a Break out Box (BoB).

A brief description of each of the items is described beneath the items.

The current status of each of the items is displayed to the right.

To reveal more items, either swipe down on the touch screen or press



Each item is described below.



RS232 Out

This setting enables or disables RS-232 Selcall information output from the Transceiver via the 25 pin auxiliary connector.

Tap **RS232 Out** from the IO screen to display the RS232 Out screen.

Select either: Disabled or Enabled.

Note: This command does not allow RS-232 control of the Transceiver as enabled when the RS-232 option is fitted. It is used to control the output of Selcall information used by some external programs such as vehicle tracking.

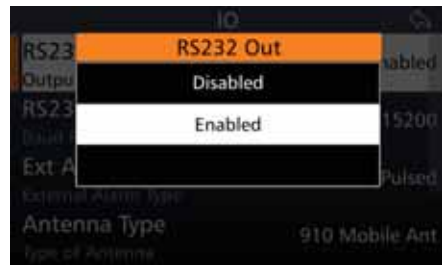

RS232 Baud Rate

This menu option allows the selection of the RS232 Baud rate.

The higher the baud rate, the faster data is sent / received. However, 9600 should be selected for compatible devices.

Tap **RS232 Baud Rate** from the IO screen to display the RS232 Baud Rate screen.

Select either: 9600 or 115200.



EXT Alarm Type

This setting sets the action of the external alarm output when a Selcall is received by the Transceiver. It can be set to either a pulse output (for use with a horn) where the output is activated 15 seconds on, 15 seconds off; or a constant output (for use with a rotating beacon). Both are reset by pressing **BACK** or the PTT button.

Tap **Ext Alarm Type** from the IO screen to display the Ext Alarm Type screen.

Select either: Pulsed or Latched.



Antenna 1 Type

This menu sets the antenna type or linear amplifier used with the Transceiver.

Tap **Antenna 1 Type** from the IO screen to display the Antenna 1 Type screen.

To reveal more items, either swipe down on the touch screen or press .

Select an antenna type from the following:

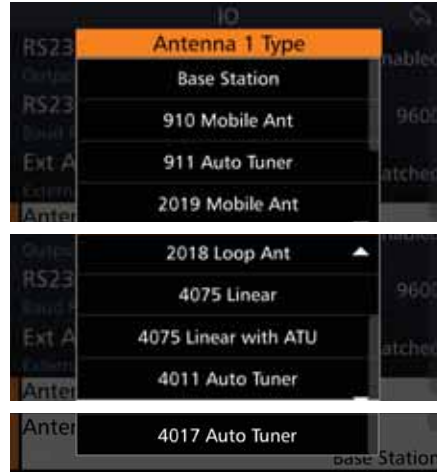

Antenna Type	Select when . . .
Base Station	Base station antennas such as the Barrett 2012 series are used. No tuning signals are emitted on channel change. This selection should also be used when operating with a Barrett 2014 manual tapped whip.
910 Mobile Ant	Using a Barrett 910 automatic tuning mobile antenna
911 Auto Tuner	Using a Barrett 911 automatic tuner
2019 Mobile Ant	Using a Barrett 2019 automatic tuning mobile HF antenna
2018 Loop Ant	Using the 2018 Mobile magnetic loop HF antenna
4075 Linear	Using the Transceiver with a Barrett 4075 series linear amplifier.
4075 Linear with ATU	Using the Transceiver with a Barrett 4075 series linear amplifier with ATU.
4011 Auto Tuner	Using a Barrett 4011 automatic tuner
4017 Auto Tuner	Using a Barrett 4017 automatic tuner

Antenna 2 Type

This option is only available if connected to a Break out Box (BoB).

Note: 4075 Linear and 4075 Linear with ATU is not available for Antenna 2 Type.

This menu sets the antenna type which may be used with the Transceiver when connected to a BoB.

Tap **Antenna 2 Type** from the IO screen to display the Antenna 2 Type screen.

To reveal more items, either swipe down on the touch screen or press



Select an antenna type from the following:

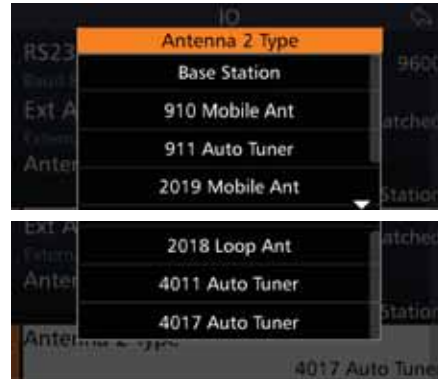

Antenna Type	Select when . . .
Base Station	Base station antennas such as the Barrett 2012 series are used. No tuning signals are emitted on channel change. This selection should also be used when operating with a Barrett 2014 manual tapped whip.
910 Mobile Ant	Using a Barrett 910 automatic tuning mobile antenna
911 Auto Tuner	Using a Barrett 911 automatic tuner
2019 Mobile Ant	Using a Barrett 2019 automatic tuning mobile HF antenna
2018 Loop Ant	Using the 2018 Mobile magnetic loop HF antenna
4011 Auto Tuner	Using a Barrett 4011 automatic tuner
4017 Auto Tuner	Using a Barrett 4017 automatic tuner



The Barrett Automatic Link Establishment (ALE) controller option simplifies the operation of HF networks by automating many of the procedures necessary to establish and maintain an HF link.

The ALE controller option provides complete inter-operability as required by FED-STD-1045 and U.S. MIL-STD-188-141C standards.

HF network stations equipped with ALE controllers automatically scan a pre-selected set of channels, listening for ALE calls.

If sounding is selected, stations will send out sounding calls to other stations at periodic intervals. These signals are analysed for link quality and stored in the sounded stations. All stations gradually build up a table of parameters which determine the best channels to use to link between specific stations. These tables are used by the ALE controller to determine the best channel to connect on when commanded by its Operator to communicate with another station.

The ALE controller's memory stores up to 8,000 sets of LQA information, 100 channel configurations, and a combination of 120 address configurations (self-address and other address). Plus, it has the ability to save unknown station information in an Auto Fill queue. This allows new stations to join the ALE network without having to manually re-program the network settings of each Transceiver in the network. There are 11 slots available for ALE Auto fill addresses.

ALE Set-up Overview

The ALE network parameters are determined by a network supervisor. The network supervisor programs all the Transceivers in the network with the required addressing and channel information using the Barrett 4050 HF SDR Programming Software (P/N BCA40001) prior to field usage.

The Barrett 4050 HF SDR Programming software (P/N BCA40001) is used to transfer pre-determined network information to each Transceiver.

As ALE's prime purpose is to automate many of the procedures necessary to establish and maintain an HF link, it is only necessary for the Operator to enter the desired station to call and activate the ALE call sequence as described in this section.

Various operational parameters can be changed within the protected menu ALE section as required by the Operator. The ALE Settings section on page 101 describes these functions.

Combined ALE / Selective Call - Overview

The combined ALE / Selective Call capability allows the user to receive and transmit ALE and Selcall type calls on channels which are programmed for ALE scan but also have Selcall enabled on them. This means that during ALE channel scanning, the Transceiver can accept incoming Selcalls. However, this feature can only be used if the ALE scan rate is set to 2 channels per second (set in the Barrett 4050 HF SDR Programming Software (P/N BCA40001)).

ALE State Settings for 2G

Tap **ALE** from the Settings screen to display the ALE Settings screen.

A list of items that may be configured is displayed.

To reveal more items, either swipe down on the touch screen or press



Note: The list shown opposite is for an ALE state of 2G mode only.

A brief description of each of the items is described beneath the items.

The current status of each of the items is displayed to the right.

Each item is described below.

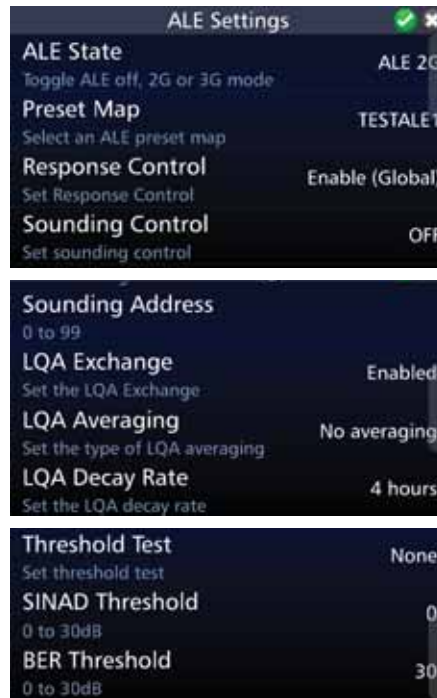

Note: The ALE Settings screen for an ALE State of 3G mode (shown opposite) differs from 2G mode.

The list of items for 2G mode is described below.

The list of items for 3G mode is shown on page 107.

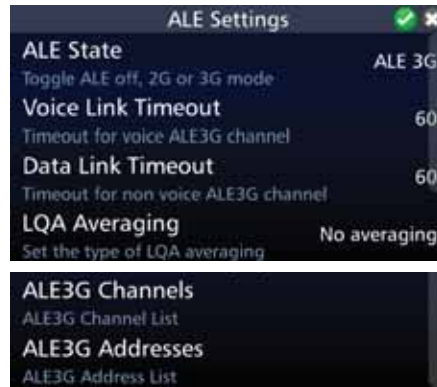

ALE State

Tap **ALE State** from the ALE Settings screen to display the ALE State screen.

Select either: Disabled, ALE 2G, or ALE 3G.

Depending on your choice, the list of items will change in the ALE Settings screen.



Preset Map

Tap **Preset Map** from the ALE Settings screen to display the ALE Preset Maps screen.

To reveal more items, either swipe down on the touch screen or press



Tap an ALE Preset Map from the displayed list.

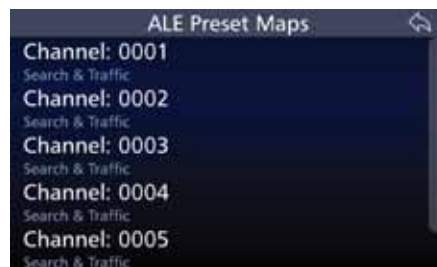

Response Control

To allow the ALE system to respond to any incoming ALE calls (including automatic soundings), ensure the Response Control is set to Enabled.

Tap **Response Control** from the ALE Settings screen to display the Response Control screen.

Select either: Off, Enable (Global), or Preset.



Sounding Control

ALE operates normally both transmitting and receiving sounds when Sounding Control is set to Enable. In some circumstances, it is desirable not to transmit soundings. In this case, Sounding Control is set to Disable. Sounding is limited to certain channels (pre-programmed by the ALE fill program). The ALE system will continue to make and respond to calls (depending on the Response Control settings).

Tap **Sounding Control** from the ALE Settings screen to display the Sounding Control screen.

Select either: Off, Enable (Global), or Preset.



Sounding Address

Configures the self address used during an automatic sounding (Sounding Control must be set to Global Sounding On). If the sounding control is set to an individual preset, the address used is dependent on the active channel.

Tap **Sounding Address** from the ALE Settings screen to display the ALE Call Self ID screen.

To reveal more items, either swipe down on the touch screen or press



Tap an ALE Call Self ID from the displayed list.

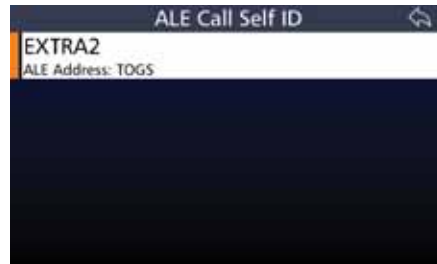

LQA Exchange

This option enables or disables the exchange of LQA information with other stations.

Tap **LQA Exchange** from the ALE Settings screen to display the LQA Exchange screen.

Select either: Disabled or Enabled.

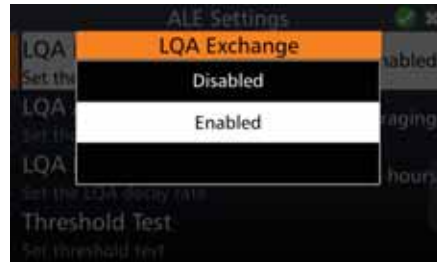

LQA Averaging

This option sets the method used to update an existing link quality value stored in ALE processor memory when the new link quality value is worse than the stored value.

The option can be set to either replace the old values with the new values or replace the old values with different weighted averages of the old values and new readings.

Averaging reduces the effect that one bad reading might otherwise have on a perfect channel. If a new reading is better than an old value, the old value is replaced by the reading. There are four different averaging formulas available:

Tap **LQA Averaging** from the ALE Settings screen to display the LQA Averaging screen.

Select either:
No Averaging,
 $(old + new)/2$,
 $((3*old) + new)/4$, or
 $((7*old) + new)/8$.



LQA Decay Rate

This option sets the artificial decay rate for the link quality information that is stored in the link quality table within the ALE processor.

Switching the sounding off and setting a decay rate of two hours would result in the recording of a perfect channel (100% channel quality) decaying to an unusable channel (0% channel quality) over a period of two hours.

Tap **LQA Decay Rate** from the ALE Settings screen to display the LQA Decay Rate screen.

Select either: Disabled, 1, 2, 4, 8, 24, or 48 hours.

To reveal more items, either swipe down on the touch screen or press



Threshold Test

Used to select which type of threshold test is used to determine what quality ALE channel is acceptable for communication.

Tap **Threshold Test** from the ALE Settings screen to display the Threshold Test screen.

Select either: None, BER, SINAD, or Both.



SINAD Threshold

This option sets the SINAD threshold (in dB) at which an ALE channel is considered usable.

Tap **SINAD Threshold** from the ALE Settings screen to display the SINAD Threshold screen.

Type a value between 0 and 30 dB, then tap **Enter**.

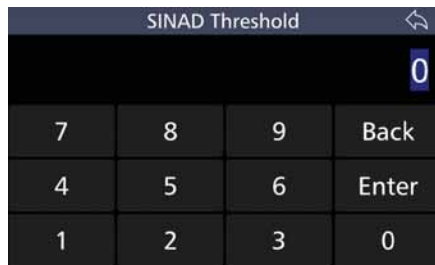

BER Threshold

This option selects the BER threshold at which an ALE channel is considered usable. If the required BER is not reached in the reply from the remote station, the link establishment process is rejected. Depending on the retry setting, the link establishment would continue on another link.

Tap **BER Threshold** from the ALE Settings screen to display the BER Threshold screen.

Type a value between 0 and 30 dB, then tap **Enter**.

Selecting 30 effectively means that all links are allowed.

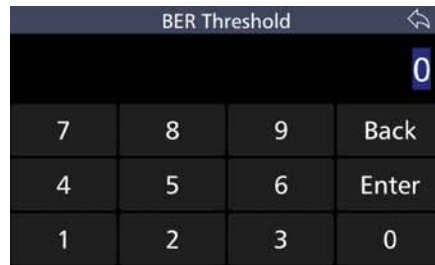

ALE State Settings for 3G

Selecting ALE State 3G Mode displays a different menu shown opposite.

These menu items are described below.

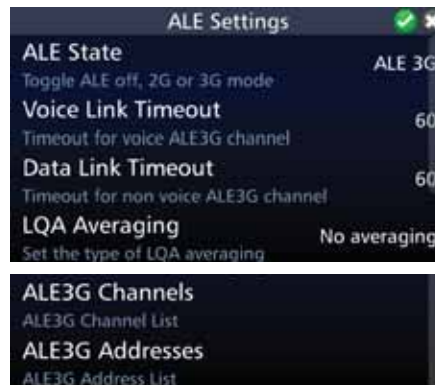

Voice Link Timeout

This option is only available if the ALE State is set to 3G.

Tap **Voice Link Timeout** from the ALE Settings screen to display the ALE 3G Voice Link Timeout screen.

Type the number of seconds and tap **Enter** to save and return to the ALE Settings screen.

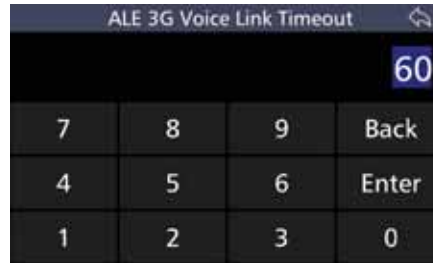

Data Link Timeout

This option is only available if the ALE State is set to 3G.

Tap **Data Link Timeout** from the ALE Settings screen to display the ALE 3G Data Link Timeout screen.

Type the number of seconds and tap **Enter** to save and return to the ALE Settings screen.

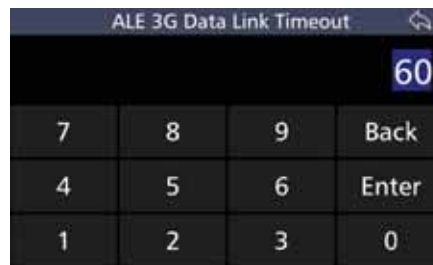

LQA Averaging

This option sets the method used to update an existing link quality value stored in ALE processor memory when the new link quality value is worse than the stored value.

The option can be set to either replace the old values with the new values or replace the old values with different weighted averages of the old values and new readings.

Averaging reduces the effect that one bad reading might otherwise have on a perfect channel. If a new reading is better than an old value, the old value is replaced by the reading. There are four different averaging formulas available:

Tap **LQA Averaging** from the ALE Settings screen to display the LQA Averaging screen.

Select either:
No Averaging,
 $(old + new)/2$,
 $((3 * old) + new)/4$, or
 $((7 * old) + new)/8$.



LSU Mode

Link Set Up is only available if the ALE State is set to 3G.

Tap **LSU Mode** from the ALE Settings screen to display the LSU Mode screen.

From the drop-down menu select either:

- Synchronous
Select the LSU mode to Synchronous to set all the stations to be in synch. However, all Transceivers have to have GPS enabled so they can all scan at the same interval on the same channel. Calls only need a short duration to enable other Transceivers to hear at the same time. The advantages of synchronous include: shorter calls, shorter soundings, and reduced network traffic.
- Asynchronous.
If there is no GPS signal, set the LSU mode to asynchronous. However, longer calls are necessary to enable successful scans. GPS is not necessary and the network doesn't have to be synchronised. Note that the linking will take longer.



ALE 3G Channels

This option is only available if the ALE State is set to 3G.

Tap **ALE3G Channels** from the ALE Settings screen to display the ALE 3G Channel List screen.

Tap the channel from the displayed list.



ALE 3G Addresses

This option is only available if the ALE State is set to 3G.

Tap **ALE3G Addresses** from the ALE Settings screen to display the ALE 3G Address List screen.

Tap the address from the displayed list.



Save the ALE Settings

After configuring the above items,

tap  to save the ALE Settings.

A confirmation message displays.

Tap **Yes**.



System Info

Tap **System Info** from the Settings screen to display the System Information screen.

A list of items that may be viewed is displayed.

A brief description of each of the items is described beneath the items.

Each item is described below.

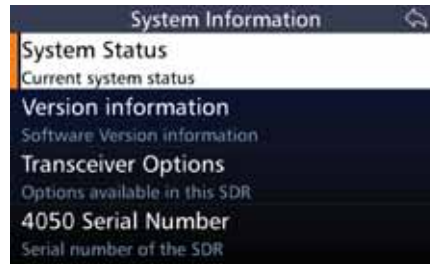

System Status

Tap **System Status** from the System Information screen to display the System Information screen.



Version Information

Tap **Version Information** from the System Information screen to display the Software Version Information screen.

A list of items that may be viewed is displayed.

To reveal more items, either swipe down on the touch screen or press



Software Version Information	
Firmware Version	controlhead-fw-dev-...
Image Version	sam-img-dev-1.0.0
Build Date	20170831_200002
Transceiver firmware version	1.0.0.9489
Core firmware version	1.28.0
ALE firmware version	Barrett-3G-DIG_AUD...
4050 User Interface	1.3.0.1772-g2e6c874
Device Driver library	1.3.0.1570-g34d7470
Communication library	1.3.0.1570-g34d7470
Data Type library	1.3.0.653-gcc015b0
Real-time Transport Protocol library	1.3.0.190-ge23e309
Audio and sound library	1.3.0.146-g88392c4
Application Utility library	1.3.1.108-g5495691
Peripheral library	1.3.0.85-gaa38c90
BoB Firmware Version	controlhead-fw-dev-...
BoB Image Version	sam-img-dev-1.0.0
BoB Build Date	20170904_200002

Transceiver Options

Tap **Transceiver Options** from the System Information screen to display the SDR Option Information screen.

A list of items that may be viewed is displayed.

To reveal more items, either swipe down on the touch screen or press



Tap each option to toggle between enabling or disabling the options.



Enter Option PINs

Tap **Enter Option PINs** from the SDR Option Information screen to display the Option PIN screen.

Tap the appropriate characters from the keyboard into the Option PIN field.

Tap **Enter** to save and return to the SDR Option Information screen.



4050 Serial Number

Tap **4050 Serial Number** from the System Information screen to display the 4050 Serial Number screen.

The 4050 serial number displays.

Tap **Ok** to close the 4050 Serial Number screen and return to the System Information screen.

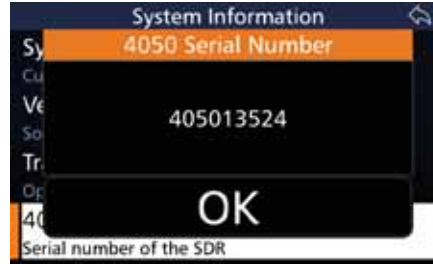

Call History



This function is also available by pressing **CALL**.

Refer to page 47 for further information.

Export



To export the device's configuration settings, insert a USB into the device's USB socket. Use either the front USB socket using a mini USB or the USB socket located at the top of the device.

Tap **Export** from the Settings screen to display the Export screen.



Tap **Export Configuration** to display the Configuration File Name screen.

The default name displays. Use the keyboard to type an alternative name of the config file to export to the USB.

Note: The file extension (.sdrpack) must not be changed.

Tap  to save.



A confirmation message displays.
Tap **Yes**.



The Export Configuration screen displays showing a progress bar confirming the progress of the export.
When prompted, tap **OK** and remove the USB.



Display

Tap **Display** from the Settings screen to display the Display screen.

A list of items that may be configured is displayed.

A brief description of each of the items is described beneath the items.

The current status of each of the items is displayed to the right.

Each item is described below.



Level of Display Backlight

Adjust the backlight level on the LCD display to one of three brightness levels.

Tap **Level of the Display Backlight** from the Display screen to display the Level of the Display Backlight screen.

Select either: Low, Medium, High or Very High.

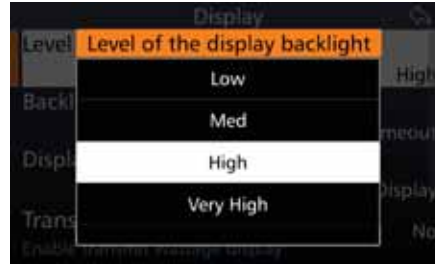

Backlight Timeout

Set the backlight timeout after the last key press.

Tap **Backlight Timeout** from the Display screen to display the Backlight Timeout screen.

Select either: Short Timeout (1 minute), Long Timeout (3 minutes), or Always On.

Note: The Transceiver's power consumption is reduced when the backlight has a short timeout.



Display Timeout Behaviour

Tap **Display Timeout Behaviour** from the Display screen to display the Display Timeout Behaviour screen.

Select either: Dim Display or Switch Off Display.



Transmit Meter Mode

This will enable the display to either show or hide the transmit wattage.

Tap **Transmit Meter Mode** from the Display screen to display the Transmit Meter Mode screen.

Select either: Chevrons or Watts.

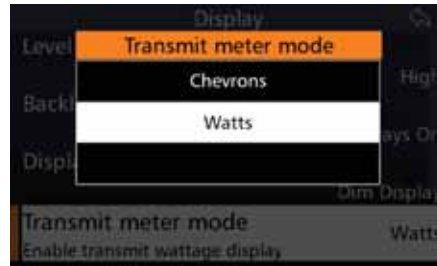

Receive Meter Mode

This will enable the display to show different units of value for the Receive Mode's signal strength.

dBm measures the units in decibels, uV measures the units in microvolts, and S Meter measures the units in S (strength) values. For example, 1 (weakest) to 7 (strongest).

Tap **Receive Meter Mode** from the Display screen to display the Receive Meter Mode screen.

Select either: dBm, uV, or S Meter.



Temperature Units

This will enable the SDR to show which temperature units to display.

Tap **Temperature Units** from the Display screen to display the Temperature Units screen.

Select either: Celsius or Fahrenheit.



Network

Tap **Network** from the Settings screen to display the Network Settings screen.

The current status of the WiFi Operation Mode is displayed to the right. Tap **WiFi Operation Mode** to change the status.



WiFi Operation Mode

Tap **WiFi Operation Mode** from the Network Settings screen to display the WiFi Operation Mode screen.

Select either: Off, WiFi Client, or WiFi Access Point.

A WiFi client connects to a specified Internet IP address and port.

A WiFi Access Point is a device that creates a wireless local area network, or WLAN, and projects a Wi-Fi signal to a designated area.

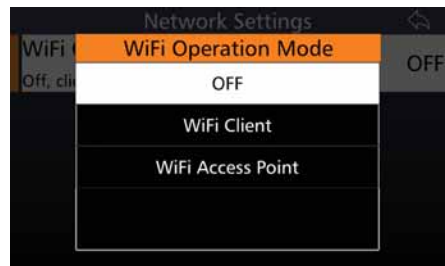

WiFi Client

If **WiFi Client** was selected from the WiFi Operation Mode screen, the following screen displays.



Tap **WiFi** from the Network Settings screen to display the WiFi Network Selection screen.

Tap **Rescan WiFi** if necessary to display more WiFi networks.

Select a WiFi network to connect to from the list.



You may be prompted for a password in order to connect to your chosen network.



Tap the **Passphrase field** from the WiFi Network Setup screen to display the WiFi Passphrase screen.

Tap the appropriate characters from the keyboard into the WiFi Passphrase field.

Tap  to save and return to the WiFi Network Setup screen.



The password entered in the Passphrase field is now displayed as asterisks.

Tap **Connect to BCGuest**.

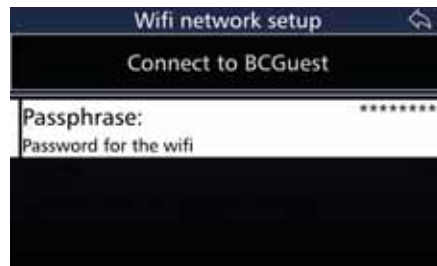

A message displays confirming that your selected network is connecting.



A further message displays confirming the WiFi connection, either successful or failed.

WiFi Access Point Mode

If **WiFi Access Point** was selected from the WiFi Operation Mode screen, the following screen displays.



WiFi Access Point Setup

Tap **WiFi Access Point** from the Network Settings screen to display the WiFi Access Point screen.

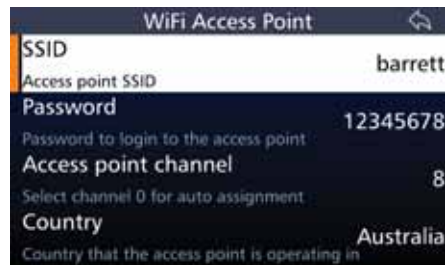

SSID

Tap **SSID** (Service Set Identifier) from the WiFi Access Point screen to display the WiFi Access Point SSID screen. The numbers in the parenthesis indicate how many characters you have used / total number of characters allowed.

Tap the appropriate characters from the keyboard into the WiFi Access Point SSID field.



Tap  to save and return to the WiFi Access Point screen.

Password

Tap **Password** from the WiFi Access Point screen to display the WiFi Access Point Password screen.

Tap the appropriate characters from the keyboard into the WiFi Access Point Password field.



Tap  to save and return to the WiFi Access Point screen.

Access Point Channel

Tap **Access Point Channel** from the WiFi Access Point screen to display the Access Point Channel screen.

Select from channel 0 to 13. Channel 0 is for automatic assignment.

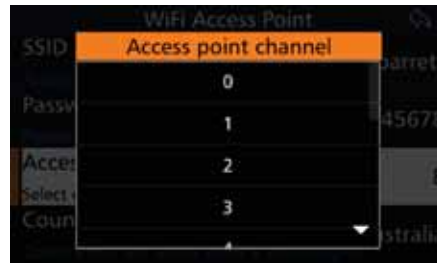

Country

Tap **Country** from the WiFi Access Point screen to display the Country screen.

Select the appropriate country.



WPS Push Button

Tap **WPS Push Button** (WiFi Protected Setup) from the WiFi Access Point Mode screen to display the WPS Connection screen.

This option will initiate the WiFi protection setup.



BoB



The Break out Box (BoB) icon only displays if the 4050 HF SDR Transceiver is connected to a BoB.

The BoB is designed to connect two antennas or two ATUs to the 4050 HF SDR Transceiver. Refer to the Break out Box Installation Manual (P/N BCM400500) for further information.

This menu setting option is only available if the Transceiver is connected to a Break out Box (BoB)

Tap **BoB** from the Settings screen to display the BoB screen.

A list of items that may be configured displays. A brief description of each of the items is described beneath the items.

Each item is described below.



BoB Name

Tap **BoB Name** from the BoB screen to display the BoB Name screen.

The numbers in the parenthesis indicate how many characters you have used / total number of characters allowed.

Use the keyboard to type or edit the name of the BoB, then tap  to save.



Network Settings

Tap **Network Settings** from the BoB screen to display the BoB Network Settings screen.

A list of items that may be configured displays. To reveal more items, either swipe down on the touch screen or press .

A brief description of each of the items which may be configured is described beneath the items.

The current status of each of the items is displayed to the right.

Each item on the list is described below.

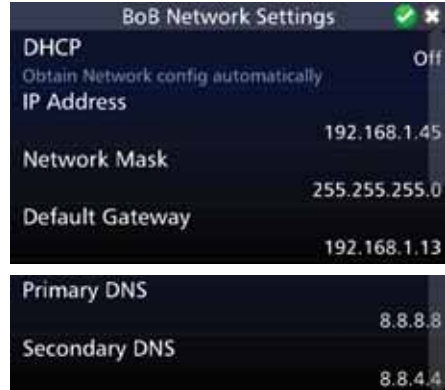

DHCP

Dynamic Host Configuration Protocol (DHCP) is a client / server protocol that automatically provides an Internet Protocol (IP) host with its IP address and other related configuration information such as the subnet mask and default gateway.

The DHCP is controlled by a DHCP server that dynamically distributes network configuration parameters, such as IP addresses, for interfaces and services.

Tap **DHCP** from the BoB Network Settings screen to display the DHCP screen.

Select **Off** to enter the network settings manually, or **On** to automatically obtain the network configuration settings.

The manual network configuration settings are described below.



IP Address

Tap **IP Address** from the BoB Network Settings screen to display the IP Address screen.

The numbers in the parenthesis indicate how many characters you have used / total number of characters allowed.

Use the keyboard to type or edit the IP Address, then tap  to save.



Network Mask

Tap **Network Mask** from the BoB Network Settings screen to display the Network Mask screen.

The numbers in the parenthesis indicate how many characters you have used / total number of characters allowed.

Use the keyboard to type or edit the Network Mask, then tap  to save.

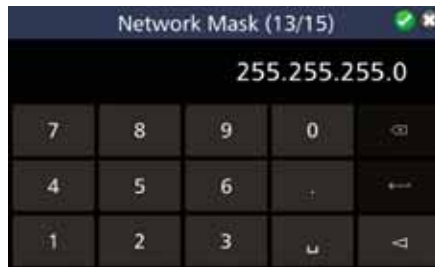

Default Gateway

Tap **Default Gateway** from the BoB Network Settings screen to display the Default Gateway screen.

The numbers in the parenthesis indicate how many characters you have used / total number of characters allowed.

Use the keyboard to type or edit the Default Gateway, then tap  to save.



Primary DNS

Tap **Primary DNS** from the BoB Network Settings screen to display the Primary DNS screen.

The numbers in the parenthesis indicate how many characters you have used / total number of characters allowed.

Use the keyboard to type or edit the

Primary DNS, then tap  to save.

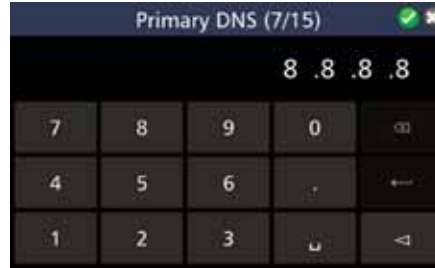

Secondary DNS

Tap **Secondary DNS** from the BoB Network Settings screen to display the Secondary DNS screen.

The numbers in the parenthesis indicate how many characters you have used / total number of characters allowed.

Use the keyboard to type or edit the

Secondary DNS, then tap  to save.

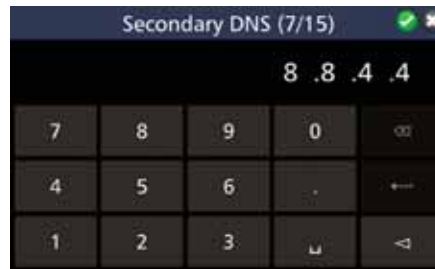

Network Status

Tap **Network Status** from the BoB screen to display the BoB Network Status screen.

A list of items display. To reveal more items, either swipe down on the touch screen or press .

The current setting of each of the items is displayed to the right.

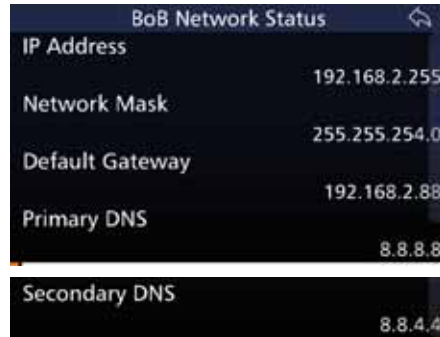

Import / Update

To update the Transceiver, insert a thumb drive containing the update files into the USB socket on top of the front panel.

Tap **Import / Update** from the Settings screen to display the Choose Action screen.

Select either Import Configuration or Program Firmware.

These options are described below.



Import Configuration

To update the configuration, tap **Import Configuration** from the Choose Action screen described above.

The Choose a File screen displays. Select the required file to import.



A confirmation message displays asking if the selected config file is to be imported.



Tap **Yes** to display the Import Configuration screen.

A progress bar indicates the progress of the import.



The Uploading Configuration screen displays showing the progress and completion of the upload.

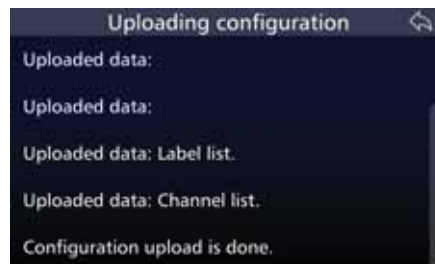

Program Firmware

To update the firmware, tap **Program Firmware** from the Choose Action screen described above.



The Choose a File screen displays. Select the required file to import.

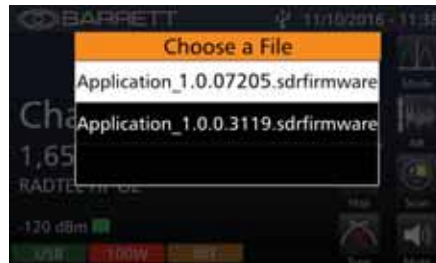

Tap **Yes** to confirm the file import.

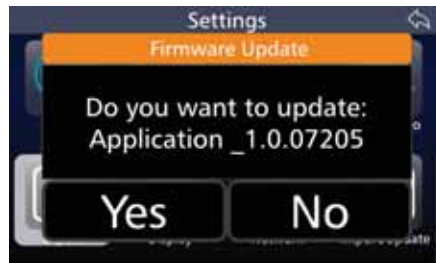

The Firmware Update screen displays showing the progress of the process.

Tap the checkbox to automatically reboot after a successful update.

Tap **Abort** to stop the process.



During the process, the current firmware will be erased.

Warning: During this stage, do not power off.



The final process indicates that the new firmware will be programmed.

Warning: During this stage, do not power off.

The Transceiver will automatically reboot after the update has been successful.



Channels



Tap **Channels** from the Home screen to display the Select Channel screen.

A list of channels along with a brief description of the channel's attributes is displayed.

For the highlighted example shown opposite, the Channel number 0002 has a channel label BARRETT; a frequency of 5940 kHz; USB mode; 125 W transmit power; and an International Selective Call mode.

To reveal more channels, either swipe down on the touch screen or press



To add a channel, see page 61.



Selecting a Channel

Tap **Channels** from the Home screen to display the Select Channel screen. Select the desired channel.



The selected channel now displays on the Home screen.

The example shows the Channel number 0002 has a channel label BARRETT; a frequency of 5940 kHz; USB mode; 125 W transmit power; and an International Selective Call mode. It also shows that the channel has -120 dBm and is receiving.



Search For a Channel

Tap  from the Select Channel screen to display the Channel Number screen.

Tap the appropriate digits for the search, then tap **Enter**.

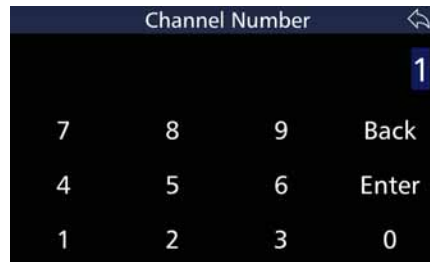

Hop

This option requires an Export Permit.

The Transceiver employs a unique frequency hopping system that uses an external ESU (Encryption Synchronisation Unit).

Note: The external ESU must be connected and providing valid data for the frequency hopping system to operate.

Selecting the Hop Band

Select a channel which is used for normal / clear transmission based on normal procedures used when using an HF system. This channel frequency and mode is used by the Transceiver to determine the hop band.

Note: The reference frequency is NOT a centre frequency for the hop band. It simply determines which of the preset hop bands are selected.

Entering the Security Code

For hopping PIN code entry, refer to SDR Options and Option PINs on page 113. The security PIN code is based on the information below.

Security Codes and Bandwidths

Security codes 00000000 to 19999999 are used for hopping ± 2 kHz

Security codes 20000000 to 49999999 are used for hopping ± 16 kHz

Security codes 50000000 to 99999999 are used for hopping ± 128 kHz

Hopping up to ± 2 kHz is useful for narrow band antennas such as when using antenna tuners in manpack operation.

Hopping up to ± 128 kHz can be used with wideband antennas such as base station broadband antennas.

Once entered, the security code for security reasons can never be retrieved or viewed.

To Enable Hopping Mode

Tap **Hop** from the Home screen to begin the hopping sequence.

As soon as the display indicates "Hopping Mode", communicating with other stations using the same channel frequency and the same hopping code, may commence.

To Disable Hopping Mode

Either tap **Hop** or press  to disable hopping mode.

The display indicates "Hopping Cancelled".

Tune

When tuning, the Transceiver will transmit, at the power level selected, a carrier on the channel selected, at 1.6 kHz above the Suppressed Carrier Frequency (SCF) (displayed frequency) of that channel.

Tap and hold **Tune** from the Home screen for three seconds to begin the automated tuning sequence.

The keypad will illuminate red whilst the Transceiver is tuning.

When the tune process is completed the display will show "Tune Ok", or "Tune Failed" in the top left-hand corner.

The VSWR briefly displays below the frequency indicating the efficiency of the selected antenna.

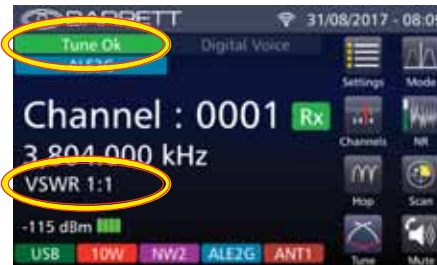

Mode

Tap **Mode** from the Home screen to cycle through USB, LSB, FSK, CW or AM for the current channel

The current mode is displayed in the lower left hand corner (green background). The example shows the Transceiver in USB mode.

Note: The mode icon will only temporarily set the mode for a selected channel, the mode reverting to that channel's programmed default mode after the channel is changed, or the Transceiver is turned off.

For further information on setting up modes for channels, see page 63.

Note: If the IF filter option is physically fitted and enabled in software, the filter will automatically be selected when either CW and AFSK mode are selected.

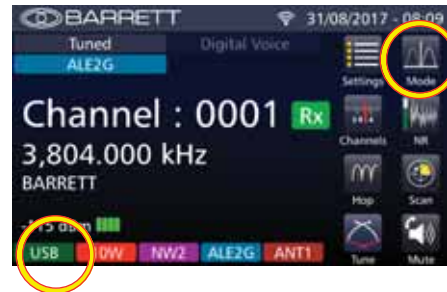

NR

This option allows the DSP noise reduction depth to be adjusted to suit the Operator's comfort requirements.

Tap **NR** from the Home screen to cycle through the options: Off, Low, Medium, or High.

The example shows an NR set to High.

After two seconds, the NR indicator is hidden and is replaced by the channel label.



When the noise reduction system is active (low, medium or high) the NR icon displays an indication of the setting.

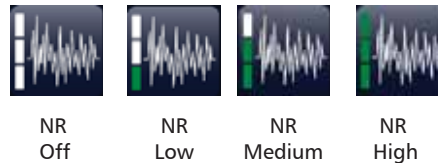

Scan

Scanning allows the Transceiver to monitor several channels for incoming calls. It is particularly useful as the nature of HF signal propagation means that not all channels are available for communications at one time. For example, a station calling a station that is in scanning mode can send a Beacon Call on any channel knowing the station it is calling is monitoring all its available channels. A response from the scanning station will only occur on channels that are open for communication.

Stations in scan can also monitor channels for voice activity or signals received that has a signal strength over a preset level.

The Transceiver will stop scanning for the following reasons:

- Signal Strength Level (SSL) mute is selected and a signal with a level greater than the pre-set threshold is received.
- Audio (syllabic) mute is selected and a voice signal is detected.

Tap **Scan** from the Home screen to initiate scanning the channels.

Whilst scanning The Rx icon changes colour from green to orange, several options on the screen are hidden (Menu, Channels, Hop, Tune, and Mode), the Scan icon is animated, and the keypad's directional keys are disabled.



To stop scanning, press .

See page 72 for setting the attributes for scanning.

Selcall Scan

When a Selcall signal is detected, and the channel has Selcall enabled, no matter which mute type is selected the Transceiver will stop scanning and decode the Selcall. The Transceiver will only stop scanning when a Selcall is detected.

Signal Strength Scan (SSL Scan)

If the signal strength mute (squelch) is active and a signal with a level greater than the pre-set threshold is received, the scan will halt. Scan will remain halted while the signal level stays above the preset threshold. Once the signal decreases below the pre-set threshold level, for a period greater than the scan dwell period, scanning will resume.

See page 77 for information on the SSL pre-set threshold and page 73 for information on the scan dwell period.

Voice (Syllabic) Scan

If the audio mute (squelch) is active and is opened, scanning will halt. Scanning will remain halted while the audio mute is open. Once the mute closes for a period greater than the scan dwell period, scanning will resume.

Mute

Tap **Mute** from the Home screen to scroll through the options:

- Audio Mute** Select Audio (syllabic) Mute (squelch) to enable the receiver audio when speech is detected on the selected channel.
Note: The syllabic mute sensitivity can be set to three levels. See page 77.
- SSL Mute** Select Signal Strength Level (SSL) Mute (squelch) to enable the receiver audio when the received signal strength exceeds the nominated threshold level.
Note: The signal strength mute level can be set to three levels. See page 77.
- Selcall Mute** Select Selcall Mute (squelch) to enable the receiver audio after a Selcall sent to the unit has been received and decoded successfully.

Mute Disabled

The example opposite shows SSL Mute.

After three seconds, the Mute indicator is hidden and replaced by the channel label.



A further indication of the mute status is shown in the lower right hand corner of the Mute icon. A red circle with a diagonal line indicates that one of the mute's status is activated. The absence of the red circle indicates that mute is disabled.

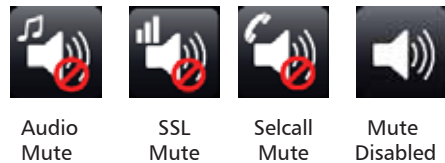

See page 77 for setting the attributes for Mute.

Swipe Menu

From the Home screen, swipe horizontally from left to right to display the following screen.

This screen shows various statistical data for the Transceiver, and if GPS enabled, displays the GPS coordinates.

From this screen various options may be set. Tap the following icons to enable or disable the options described below.



When enabled, these icons will illuminate green. If an option is not enabled, the icons will appear grey.



Noise Blanker

Used to reduce interference from vehicles with petrol engines (see page 94).



TC2 Program

If a TC2 module is installed and TC2 Programming Mode is enabled, the icon will display TC2 Program. If TC2 Programming Mode is disabled, the icon will be blank. (See page 58.)



Internal Modem

If a TC2 module is not installed, the TC2 Program icon will be replaced by the Internal Modem icon. This will toggle between two internal modems (2020 or 4026).



OEM Secure

Enables Voice Encryption (See page 56)

Note: If both the OEM Secure and Digital Voice options are fitted, when one is enabled, the other is automatically disabled.



Digital Voice

Used to increase voice quality and reliable communications.

When transmitting or receiving a call using digital voice, the recipient's Transceiver will automatically change to digital voice.

The home screen will also confirm when digital voice is enabled.



Wireless Application

The Barrett 4050 wireless application supports Windows PCs, iOS and Android devices for wireless voice and radio control.



Downloading the Barrett SDR Remote Control Head Setup App

For Windows PCs

Warning: It is essential to install the Bonjour app prior to installing the Barrett Control Head Installer app.

1. Download the BonjourPSSetup.exe from:

“https://support.apple.com/kb/DL999?viewlocale=en_US&locale=en_US”



Follow the online instructions to install the Bonjour app.

2. Contact support@barrettcommunications.com.au for instructions on downloading the Barrett SDR Remote Control Head Setup.exe

For iOS and Android Devices

The Barrett SDR Control Head app may be downloaded from:

- The App Store (iOS devices), or
- The Google Play store (Android devices).

Android devices can also download the app directly from the SDR Front Panel. This is preferable as the firmware version of the SDR is guaranteed to match the app version.

Installing the Barrett SDR Remote Control Head Setup App

For Windows PCs

Note: Windows 7 is the minimum system requirement for running this app.

Prior to executing the Setup file, check whether there is an existing installation of the app. This must be uninstalled first.

To install the app, double-click the Barrett SDR Remote Control Head Setup.exe file and follow the online instructions.

The final installation screen is shown opposite with a reminder to install the Bonjour app, (link provided).

Select the **Open Barrett SDR Remote Control Head** checkbox and click **Finish** to display the Connect to SDR screen.

Select the device to connect to and

tap .



The Connecting screen displays and the Busy icon animates as it attempts to connect the wireless device to the SDR.



After successfully connecting, the animating icon disappears and the wifi connection icon changes from  to .



For iOS and Android Devices

iOS devices can install the app by following the default Apple process after downloading.

Android devices installing the app from the SDR Front Panel need to follow these typical procedures.

Check whether there is an existing installation of the app. This must be uninstalled first.

To uninstall an application, go to Settings > Applications
Select the existing installation.

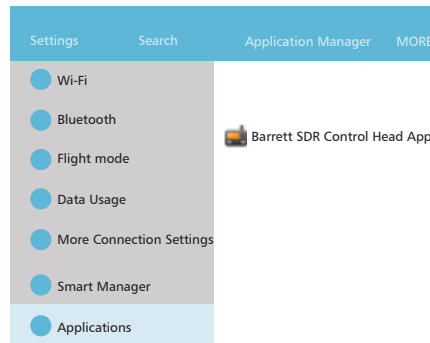

BARRETT 4050 HF SDR TRANSCEIVER - OPERATING AND INSTALLATION MANUAL

Tap **Uninstall** to remove the app.

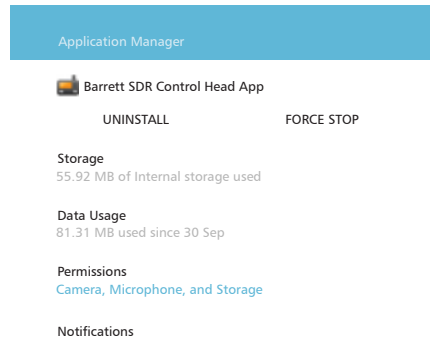

Connect the device to the SDR ensuring the OTG (On-The-Go) adapter is connected to the device and not the Transceiver



After the connection is established, the device's File Manager displays.

Select:

BarrettSDRControlHead.apk

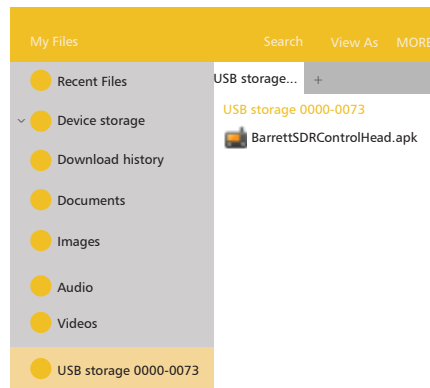

A warning message displays blocking the installation.

Tap **Settings**.

Note: If the CPU architecture of the Android tablet is "x86" (Intel Inside), install "BarrettSDRControlHead-x86.apk" instead of "BarrettSDRControlHead.apk".

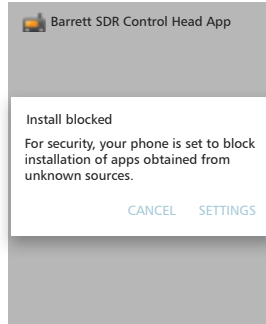

Select **Unknown Sources**.

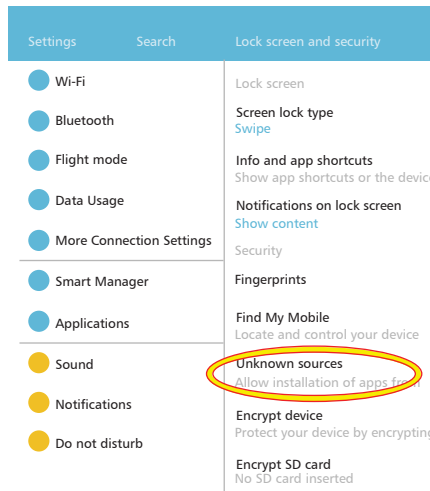

A warning message displays.

Tap **OK**.

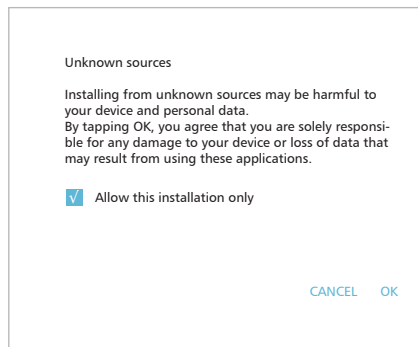

Tap **Install** to install the app.

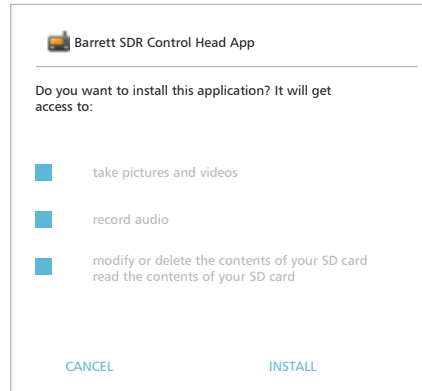

Connecting the Wireless Device to the SDR

Preparing the SDR

Prior to invoking the wireless app, ensure the wifi dongle is inserted in the USB socket located on the top of the front panel of the SDR.

Also, ensure the SDR's network setting's WiFi Operation mode is set to enable a connection between the SDR and the Wireless device.

The example shows the WiFi Operation mode set to WiFi Client and is connected to a WiFi network labelled SDR Access RD.

For further information on WiFi Clients, refer to the Network section on page 118.



Invoking the App

To invoke the application, tap  from the wireless device's App screen.



A progress bar displays as the program loads, followed by a splash screen and then the Connect to SDR screen.

Overtyping the SDR IP address if necessary (the example shows 192.168.3.2)

then tap  to connect the wireless device to the SDR.



The Busy icon animates as it attempts to connect the wireless device to the SDR.

After successfully connecting, the animating icon disappears and the wifi connection icon changes

from  to .

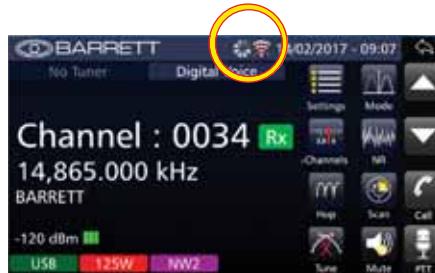

Exploring the App

The display and icons shown on the wireless device are the same as the front panel on the 4050 SDR, but includes an additional column of icons replicating the keypad operations of the 4050 SDR.



The functionality of the Wireless application and the 4050 SDR is essentially the same.

Disconnecting the Wireless Device from the SDR

From the Home screen, swipe horizontally from left to right to display the following screen.

Tap .



A confirmation screen displays.

Tap **Yes**.



Cooling Fan

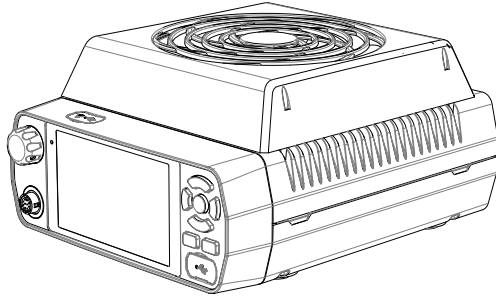

The cooling fan is an optional extra which may be added to the 4050 HF SDR. The cooling fan requires no user input as it is temperature controlled by software, automatically activating when necessary.

Installing the Cooling Fan

Attach the cooling fan to the SDR by carefully aligning the connector pins located beneath the cooling fan with the socket on top of the SDR as shown below.

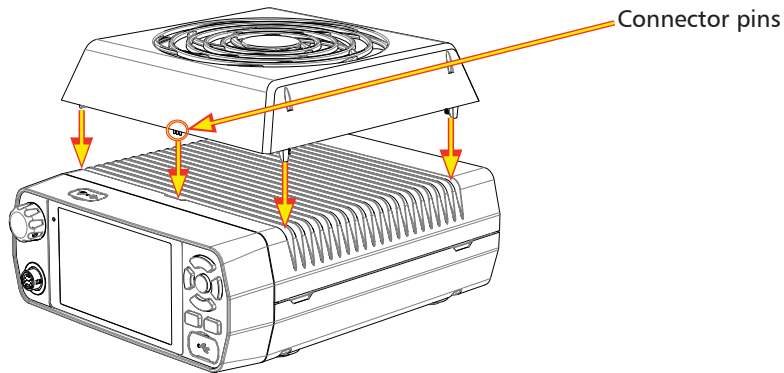

Four screws (located in the four corners of the cooling fan) are used to secure the cooling fan to the SDR.

To uninstall the cooling fan, simply reverse the installation procedure.

Connectors

Note: All connectors described below are viewed looking at the rear of the Transceiver.



Power Connector

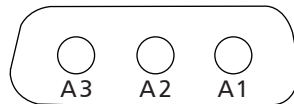

- A1 12 V DC - 28 V DC
- A2 Reserved
- A3 Ground

GPS Connector

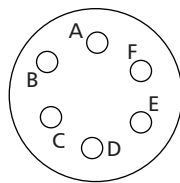

Signal

- A. 1PPS
- B. NMEA+
- C. 5 V GPS
- D. CW Key
- E. GND
- F. Reserved

Level

- 1 Pulse per second
- NMEA Data positive
- GP Voltage 5 V
- Active Low
- Ground

Aux Control Head / BoB Connector

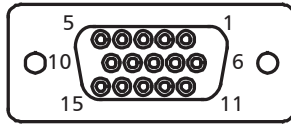

1. VCC
2. CAN Bus positive pin
3. CH Audio+
4. Not Connected
5. Ground
6. Ground
7. CAN Bus negative pin
8. CH Audio-
9. Not Connected
10. Line Out
11. Linear amp ALC for Break out Box
12. 13V8 Out
13. Line In+
14. Line In-
15. 1PPS

Auxiliary Connector

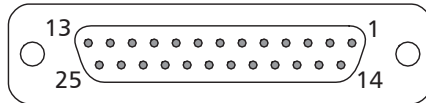

Pin	Name	Description of Function	Level
1	Ground	Ground	0 V
2	Rx Data	RS-232 data input	True RS-232
3	Tx Data	RS-232 data output	True RS-232
4	Reserved		
5	Reserved		
6	Reserved		
7	RS-232 Gnd	RS-232 Ground	0 V
8	ALC In	Ext. ALC from Linear Amp	0-10 V

BARRETT 4050 HF SDR TRANSCEIVER - OPERATING AND INSTALLATION MANUAL

Pin	Name	Description of Function	Level
9	PTT In	Auxiliary PTT input	Active low 0 V
10	Aux dig in 1	Scan stop input from external modem	Active low 0 V
11	Bal. Tx Audio In	Balanced Tx audio input (with pin 24)	600 Ω -24 dBm to 0 dBm
12	Bal. Rx Audio Out	Balanced Rx audio output (with pin 25)	600 Ω -6 dBm to +9 dBm
13	Ground	Ground	0 V
14	Reserved		
15	Reserved		
16	Reserved		
17	Reserved		
18	Aux dig out 4	Selcall alarm	Active low 0 V
19	Aux dig out 5	Audio mute state	Active low 0 V
20	Reserved		
21	PTT / C-Mute	PTT Out / Receiver Cross Mute	Active low 0 V
22	Reserved		
23	+13.8 V Fused Out	+13.8 V Output to power auxiliary equipment	13.8 V @ 2 amp
24	Bal. Tx Audio In	Balanced Tx audio input (with pin 11)	600 Ω -24 dBm to 0 dBm
25	Bal. Rx Audio Out	Balanced Rx audio output (with pin 12)	600 Ω -6 dBm to +9 dBm

Note: Balanced Rx audio out on Pin 25 and Pin 12 can be un-muted or follow the audio mute depending on the configuration in the protected menu I/O section.

ATU Connector

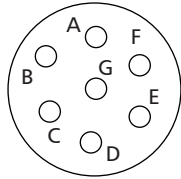

Signal

- A. GND and shield
- B. RS-232 RX / GPS Data
- C. 1PPS
- D. Scan
- E. Tuned
- F. ATU V+
- G. RS-232 TX

Level

- Ground and cable shield
- Receive data line of RS-232
- 1 Pulse per second
- ATU Scan line
- ATU Tuned signal
- ATU Voltage 13V8
- Transmit data line of RS-232

Microphone Connector

Located on the Front Panel.

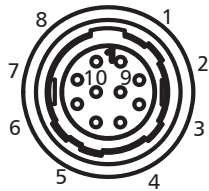

Signal

- 1. MicH
- 2. MicL
- 3. GND
- 4. PTT
- 5. CH UP
- 6. CH DN
- 7. Reserved
- 8. Reserved
- 9. SPKR+
- 10. SPKR-

Level

- Microphone audio high
- Microphone audio low
- Ground
- Low going PTT
- Channel up
- Channel down
- Reserved
- Reserved
- Speaker microphone positive
- Speaker microphone negative

Control Head Rear Panel Connector

Plug located on the rear of the Front Panel.

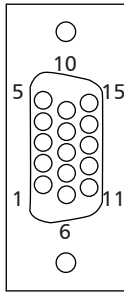

1. VCC
2. CAN Bus positive pin
3. CH Audio+
4. SPKR-
5. Ground
6. Ground
7. CAN Bus negative pin
8. CH Audio-
9. SPKR+
10. Head Detect
11. Not Connected
12. Not Connected
13. Not Connected
14. Not Connected
15. Not Connected

Cooling Fan Connector

Socket located on the top of the SDR.

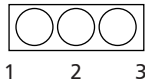

(Viewed from the rear of the SDR)

1. Ground
2. + 12 V DC
3. Fan detect

Specifications

General

Standards	<p>Designed to meet or exceed:</p> <p>FCC - Part 87 and Part 90</p> <p>CE[#]</p> <p>Australian/ New Zealand standard AS/NZS 4770:2000 and AS/NZS 4582:1999</p> <p>EMC and vibration standard IEC 945[#]</p> <p>MIL-STD 810G for shock , vibration, dust, temperature, altitude, humidity, and mould.[#]</p> <p>NTIA[#]</p> <p>JITC[#]</p> <p>[#] <i>Approval pending</i></p>
Transmit frequency range	1.6 MHz to 30 MHz
Receive frequency range	250 kHz to 30 MHz
Frequency stability	±0.5 ppm (±0.3 ppm optional)
Frequency resolution	1 Hz tunable receiver
Operating modes	J3E (USB, LSB) - H3E (AM) - J2A (CW) - B2B (AFSK) software defined filter bandwidth
Filter bandwidth	Fully software defined. From 300 Hz to 3000 Hz and beyond. Optionally up to 16 kHz
Operating temperature	-30°C to +70°C relative humidity 95% , non-condensing
Frequency hopping	25 or 5 hops per second with External Synchronisation Unit (ESU) supplied when the option is fitted. The Barrett frequency hopping system requires no master station, all stations are synchronised and ready to communicate on switch on, synchronisation is not effected by propagation or local interference and there is no late entry synchronisation delay.
Supply voltage	12 V to 28 V DC operation

BARRETT 4050 HF SDR TRANSCEIVER - OPERATING AND INSTALLATION MANUAL

Selcall system	Based on CCIR 493-4, four and six digit systems. Protocol available for free distribution. Fully compatible with other major HF manufacturers' four and six digit systems including encrypted systems
ALE Standards	2G and 3G ALE
Current consumption	350 mA standby (muted)
Channel capacity	Up to 1000 programmable channels (depending on the 4050 variant (simplex or semi-duplex)
Switching speed	Less than 15 ms Tx to Rx, Rx to Tx
Weight	2.55 kg (local control configuration)
Width	188 mm
Depth	251 mm (local control configuration)
Height	83 mm

Receiver

Sensitivity	-121 dBm (0.20 μ V) Pre amp off for 10dB SINAD
Selectivity J3E	-1 kHz and +4 kHz better than 70dB -2 kHz and +5 kHz better than 70dB -5 kHz and +8 kHz better than 70dB
Selectivity J2B (optional)	-500 Hz and +500 Hz better than 60 dB The level of an unwanted signal above the level of a wanted signal that will reduce the SINAD of the wanted signal from 20 dB SINAD to 14 dB SINAD
Blocking	-20 kHz and +20 kHz better than 71 dB. The level of an unwanted signal above the level of a wanted signal that will reduce the SINAD of the wanted signal from by 6 dB or cause an output level change of 3 dB
Intermodulation	Better than 89 dB μ V - The level of two unwanted signals, that are within 30 kHz of the wanted signal, above the level of a wanted signal that reduces the SINAD of the wanted signal to 20 dB
Spurious response ratio	Better than 70 dB

BARRETT 4050 HF SDR TRANSCEIVER - OPERATING AND INSTALLATION MANUAL

Reciprocal mixing	Better than 105 dB μ V
In-band IMD	Better than 34 dB
Audio output	4 W into 4 ohm at less than 2% distortion
Audio response	Less than 6 dB variation from 350 Hz to 2700 Hz

Transmitter

RF output power	150 W PEP Voice (with 24 V supply) 125 W PEP Voice (with 13.8 V supply)
Duty cycle	100% data with fan option
Intermodulation Products	Better than -31 dB below PEP (25 dB below two tone peak)
Audio frequency response	Less than 6 dB variation 350 Hz to 2700 Hz
Current consumption	Voice average less than 9 amps typical Two tone less than 12 amps typical Standby Max 0.5 A 13.8 V DC - Max 21 A (full power 125 W) 24 V DC - Max 15 A (full power 150 W)



Installation

This section describes how to change the 4050 Transceiver from a desktop unit to a remote control (trunk mount) unit using the Mobile Pack P/N BCA40501.

Mobile Pack

(P/N BCA40501)

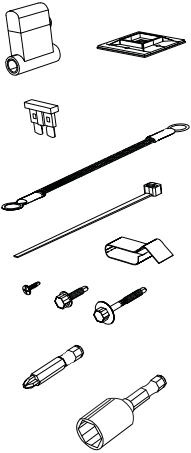
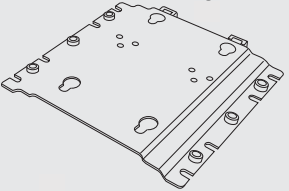
The mobile pack contains the following components:

Item	Description	Barrett P/N
	Barrett installation kit	BCA40004
	Universal mounting cradle	SA-45060
	Screws and capstans	MW-45027

Item	Description	Barrett P/N
	RAM mount	PW-33334

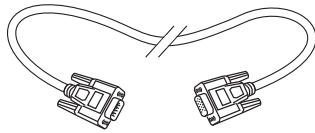

Six metre control head cable with DE-15 connectors

SA-45100

To install the mobile pack, complete the following steps:

1. Invert the SDR and use a Posidrive #2 screwdriver to loosen (but not remove), the two front panel securing screws located immediately behind the front panel.
2. Gently pull the front panel from the SDR to remove it.

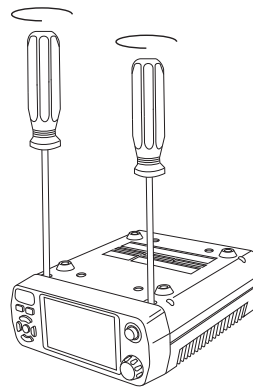

3. Fit the supplied capstans to the four holes as indicated.

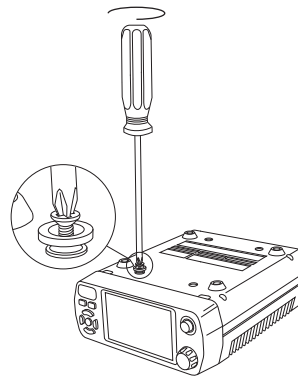

4. Attach the universal mounting cradle **3** to the desired location using the fixings provided.
5. Align the SDR's capstans into the key holes on the universal mounting cradle and slide to secure it.
6. Attach the RAM mount **4** to the desired location and affix the front panel to it using the two screws provided.
7. Plug the six metre control head cable **6** into the socket located at the front of the SDR and secure using the strain relief screws.
8. Remove the two plug retaining screws **7** from their storage location as indicated and fit securely in position above and below the control head connector. *CAUTION: Do not over tighten.*
9. Plug the other end of the six metre control head cable into the rear of the front panel **2** and secure using the strain relief screws.
10. Plug the loudspeaker connector into the socket located at the rear of the front panel **5** as indicated below.

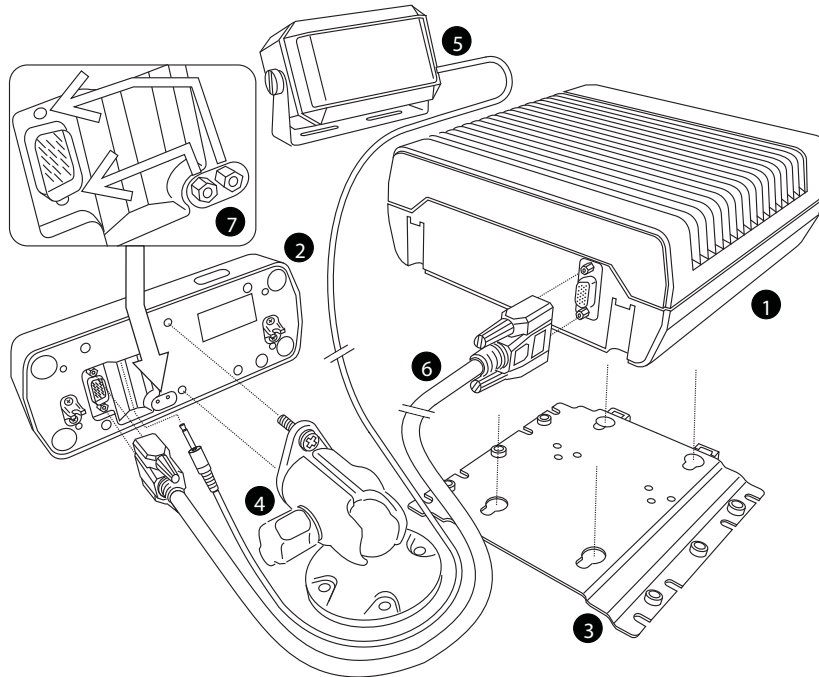

- 1 SDR
- 2 SDR Front Panel (Control Head)
- 3 Universal mounting cradle
- 4 RAM mount
- 5 Loudspeaker
- 6 Six metre control head cable with DE-15 connectors
- 7 Details for fitting the two plug retaining screws

Land Based Systems

This section provides instructions for the installation of land based HF communication equipment.

Most of the installation work can be performed by non-technical personnel if they carefully follow the instructions given in this manual. However, it is recommended that the completed installation be checked by a suitably qualified technician. In some equipment configurations, technical adjustment is required for the equipment to operate correctly.

Note: Some equipment has specific instructions supplied with it. Those instructions over-ride the general guidance of this manual, and must be followed in detail.

Unpacking and Inspection

When unpacking the Transceiver, check the contents against the packing note provided. Before discarding the carton, check that all accessories have been removed and are not mislaid in the packing material. Inspect the equipment for any transit damage. If damage has occurred, notify your supplier immediately. Failure to do this could affect the warranty covering the equipment.

Fixed Station Installations

Site Selection Recommendations

The success of every HF Radio system is primarily measured by its ability to receive weak signals and to transmit RF power efficiently. A number of important factors need to be considered to achieve success. These include: frequency selection, time of day and ambient noise at the receiver site. Frequency and time of day are factors which can be used to calculate the maximum usable frequency (MUF) and lowest usable frequency (LUF), for a particular time of day, using prediction software freely available on the internet. A typical example of this is VOACAP, <http://www.voacap.com/prediction.html>

Site selection and system design go hand in hand and should be considered before any equipment is purchased. Forcing the radio system into an unsuitable site will undoubtedly result in disappointing if not unworkable performance of the system. Little can be done to improve an installed system if, for example, the ambient RF noise is unacceptably high.

It is recommended that site evaluation be done before any system designs are finalised to avoid system performance disappointment.

The following should be considered when choosing a position for the Transceiver:

Operating Convenience	The Transceiver should be placed so that the operator is comfortable and any required facilities are easily accessible.
Air Circulation	Most Transceivers rely on air flow around cooling fins to dissipate heat generated by the transmitter. The mounting position must allow free air flow around these fins.
Proximity of Transceiver to Antenna	When using RG-58 coaxial cable from the Transceiver to the antenna, a cable length of no more than 30 metres is recommended. Should a run of more than 30 metres be required, it is recommended that a low loss coax such as RG-213 or RG-8 be used.

It is recommended that the Transceiver chassis is connected to ground using the bolt on the rear panel to stop pick-up of unwanted noise from local power supplies and electrical equipment.

Power Supply

When 12 V DC is supplied to the 4050 Transceiver, the PEP Voice output power will be restricted to 125 W. Conversely, when 24 V DC is supplied to the 4050 Transceiver, the PEP Voice output power will achieve 150 W.

Power output regulation is done automatically based on the DC voltage presented to the Transceiver DC input connector. The Barrett 4022 Power Supply is available in two versions, the BC402200 (12 V DC) and the BC402201 (24 V DC) version. Each power supply version is capable of operation with AC mains input voltage between 88 and 256 V AC.

In base station installations where no mains supply is available, various Barrett solar power supply versions are available depending on the system configuration requirement.

Note: Some installations use an AC battery charger to float charge the supply battery. Battery chargers can produce electrical noise from the rectifier diodes. This noise causes a static type of interference in the receiver. It may be necessary, therefore, to switch off the battery charger whilst the Transceiver is in use. If float charging of batteries is required for installations with unreliable AC power supply, it is recommended that a Barrett BC402200 or BC402201 be used as each provides a three stage charge facility to maintain a battery without the noise problem described above.

Voltage Drop

The average current consumption of the Transceiver is low but during transmission of voice peaks, high current is needed for short intervals. This means that the power supply cable must be heavy enough to supply these short duration current peaks without excessive voltage drop. Preferably, only use the power cable supplied with the Transceiver. If extra cable is required, use a cable with a conductor square area of no less than 8 mm². Unwanted voltage drop will also occur if incorrect wiring techniques such as poor choice of connection points and incorrect use of terminal lugs are used.

Protection Fuse

The Transceiver is provided with adequate internal protection. However, the fitting of an external fuse is considered necessary, not only for protection of the Transceiver itself, but to ensure that in the event of damage to the cable, a fire risk does not exist. The fuse used must be installed in the active wire as close as possible to the battery, and must be of a type which has a low voltage drop at the peak currents expected.

Note: In-line 3AG glass fuses are not suitable. An ATC automotive blade type fuse rated at 25 A with a suitable high current ATC fuse holder rated at 30 A or more should be used. These type of fuses and holders are contained in our standard installation kit (Barrett P/N BCA40004) or are available individually (Barrett P/N BCA20021).

Antenna

The antenna is a most critical part of the complete radio installation. It must accept the output power from the transmitter, radiate that power with minimum loss and in the receive mode, accept weak signals for input to the receiver.

Incorrect antenna installations will yield poor system performance and are often the cause of complaints of poor Transceiver performance.

A range of antennas is available from Barrett to suit most small fixed stations. Detailed instructions are included with each antenna.

912 Single Wire Broadband Dipoles

(Barrett P/N BC91201)

Barrett 912 single wire broadband dipoles are ideal for base stations that require operation on multiple frequencies throughout the HF spectrum using a single antenna.

The 912 antenna can be mounted either in a horizontal or inverted 'V' configuration as illustrated in the following diagrams. In the horizontal configuration, the major radiation direction is broadside to the antenna. When mounted in the inverted 'V' configuration, the antenna becomes fairly Omni-directional. In the horizontal configuration, the minimum distance between the masts is 49 metres and the recommended mast height is 15 metres. In the inverted 'V' configuration the recommended mast height is 15 metres.

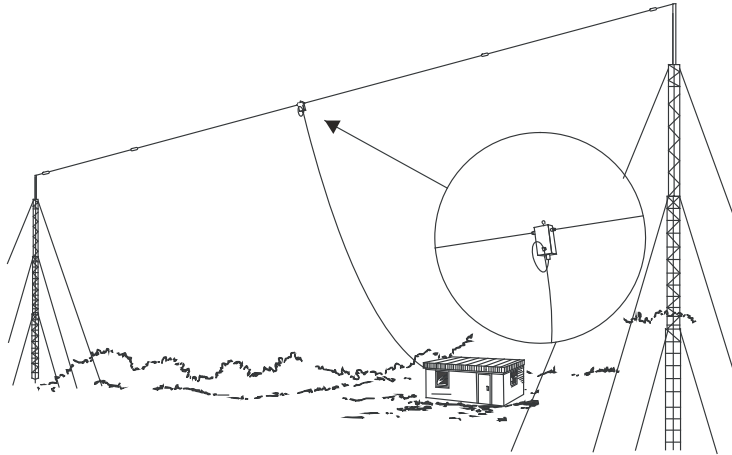

At this height, the two metre stub masts are each installed at a minimum of 19 metres from the mast base. In locations with limited space, the antenna can be mounted with the ends past the load resistors drooped down towards the ground. White nylon supports located just past the load resistors are provided to attach halyards for this configuration. In this configuration, the minimum distance between masts is reduced to 33 metres. Support towers may be either lattice masts as illustrated, tubular telomasts or other support structures that may be available locally. It is recommended that the halyards used to support the antenna be either UV stabilised Dacron cord or wire rope and that pulleys should be of stainless steel construction.

Install the antenna as illustrated in the diagrams, in the inverted 'V' configuration the eye on the top of the balun is used to attach the support halyard.

BARRETT 4050 HF SDR TRANSCEIVER - OPERATING AND INSTALLATION MANUAL

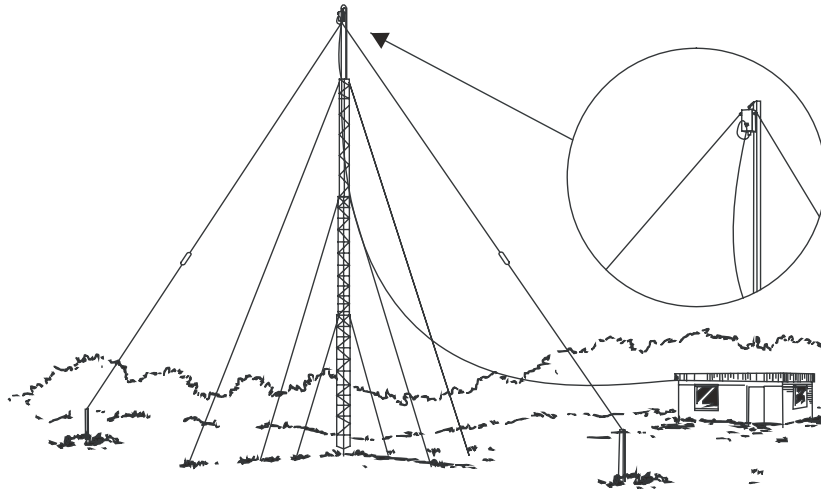

As with all antenna installations ensure the antenna is as far from sources of electrical interference as possible and in a position that makes it impossible for the antenna to come in contact with high voltage overhead mains wiring.

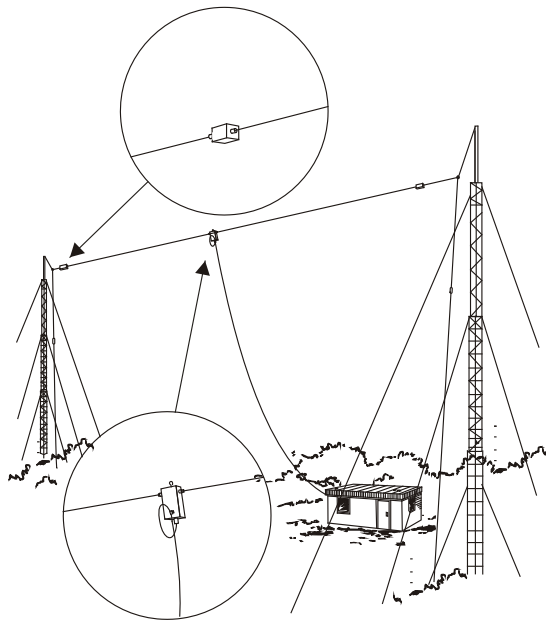

912 Multi wire Broadband Dipoles

(Barrett P/N BC91200, BC91202 and BC91203)

Barrett 912 broadband dipoles are ideal for base stations that require operation on multiple frequencies throughout the HF spectrum using a single antenna.

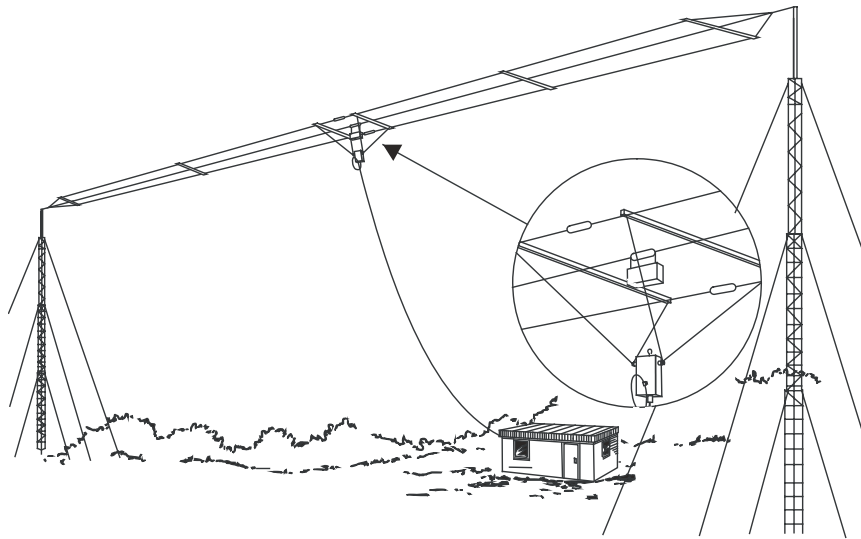

The Barrett 912 antenna can be mounted either in a horizontal or inverted 'V' configuration as illustrated in the following diagrams. In the horizontal configuration, the major radiation direction is broadside to the antenna. When mounted in the inverted 'V' configuration, the antenna becomes fairly omni-directional. In the horizontal configuration, the minimum distance between the masts is 32 metres and the recommended mast height is 15 metres. In the inverted 'V' configuration the recommended mast height is 15 metres and at this height the 2 metre stub masts are each installed at a minimum of 19 metres from the mast base. In this configuration the mast must have an offset or out-rigger bracket, at least 0.8 metres long, to hold the antenna away from the mast. Support towers may be either lattice masts as illustrated, tubular telomasts or other support structures that may be available locally. It is recommended that the halyards used to support the antenna be either UV stabilised Dacron cord or wire rope and that pulleys should be of stainless steel construction.

BARRETT 4050 HF SDR TRANSCEIVER - OPERATING AND INSTALLATION MANUAL

Install the antenna as illustrated in the diagrams, in the inverted 'V' configuration the eye on the top of the balun is used to attach the support halyard. In the horizontal configuration the balun hangs below the antenna.

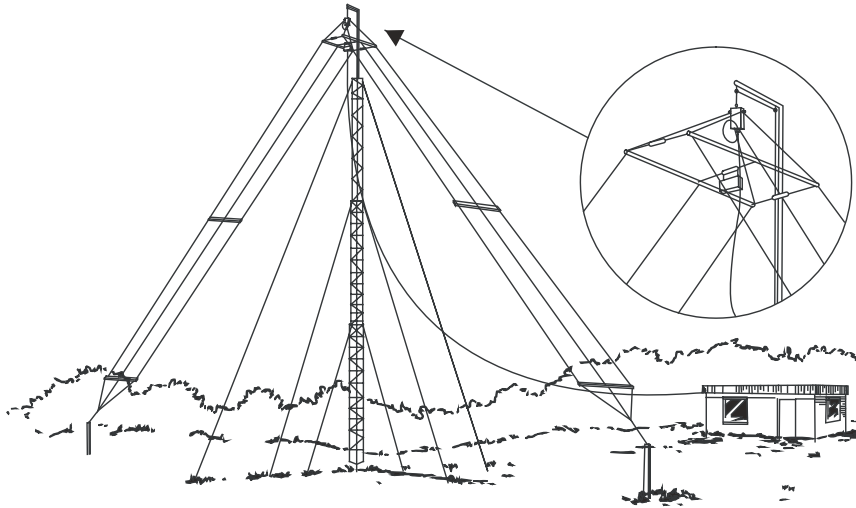

As with all antenna installations ensure the antenna is as far from sources of electrical interference as possible and in a position that makes it impossible for the antenna to come in contact with high voltage overhead mains wiring.

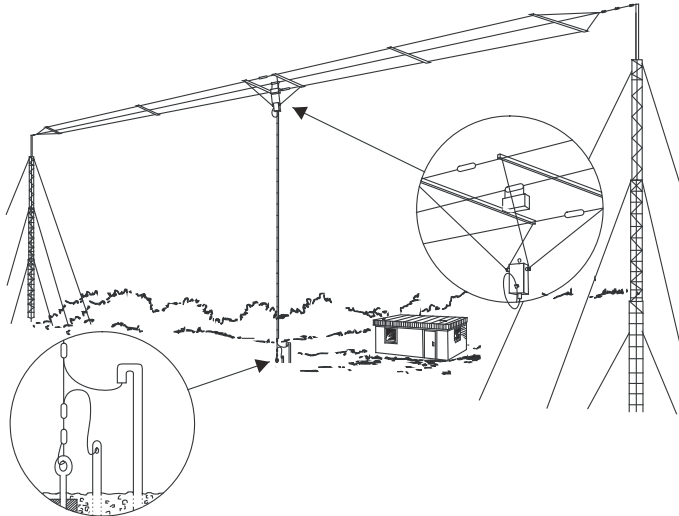

913 Series Helical Dipoles

(Barrett P/N BC91301 to BC91305)

913 series helical dipole antennas are compact and easily installed, having extremely narrow bandwidth characteristics and a performance approaching that of a wire dipole when used at frequencies over 4.5 MHz. The helical dipole antenna is fed by a single coaxial feeder and can accommodate up to five frequencies.

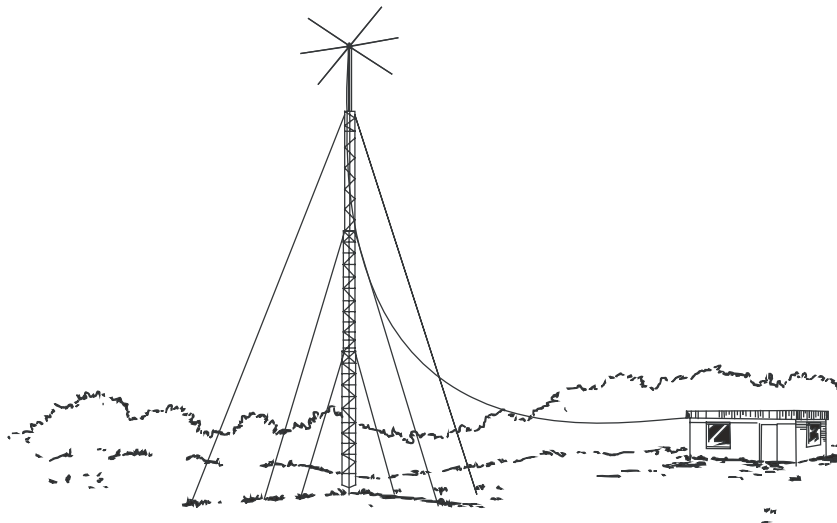

The 913 helical dipole requires a 50 mm diameter mounting pole. This pole should be long enough to place the helical dipole at least five metres above any obstruction. Alternatively, the helical dipole can be mounted on top of a mast or tower. Make sure that the site selected for the antenna is as far from any source of electrical interference as possible and that under no circumstances can come in contact with high tension power lines.

After mounting the helical dipole hub on the mounting pole, remove the front circular cover, pass the coaxial cable through the hole at the bottom of the hub. Screw the UHF connector into the balun. Now screw the helical dipole elements onto the hub. Each element has its frequency marked on the brass ferrule used to screw the element onto the hub. Assemble the helical dipole elements in the positions on the hub as indicated by the diagram enclosed in the hub. Failure to assemble the helical dipole as indicated in this diagram will cause tuning problems.

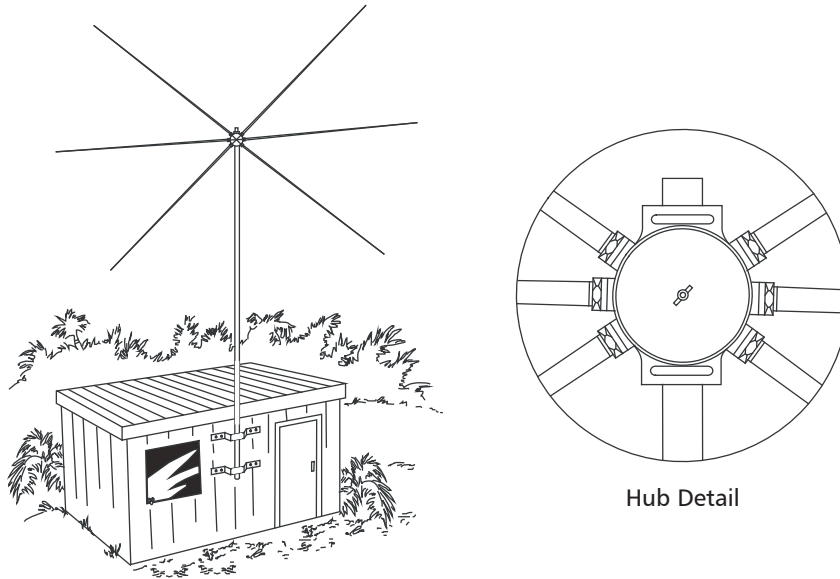

Helical dipoles are manufactured to specific frequencies, but may require fine tuning after installation. To enable this, the dipole elements have an adjustable length tip to allow fine tuning for optimum VSWR during installation. Install the antenna in its final position and check the VSWR on each of the frequencies that the antenna was manufactured for. Should the VSWR be greater than 1.5:1 the antenna will require adjustment. If a tunable transmitter is available, determine on each frequency the helical dipole was manufactured for, at what frequency the best VSWR is obtained. If this occurs at a frequency below the required frequency then the tips will have to be shortened on the pair of elements corresponding to that frequency. If the best VSWR occurs on a frequency higher than the required frequency then the tips will have to be lengthened. Adjust both ends by an equal amount and repeat the above sequence until an optimum VSWR is obtained. If a tunable transmitter is not available, use a method of trial and error to adjust the length of the tips, a little at a time, until an optimum VSWR is obtained. Remember always adjust each pair of elements by the same amount at each adjustment.

915 Wire Dipole

(Barrett P/N BC91500)

Single frequency wire dipole antennas, spot-tuned to the required operating frequency(s), are the most efficient antennas for use in HF base stations. They are simple to install and have a relatively narrow bandwidth.

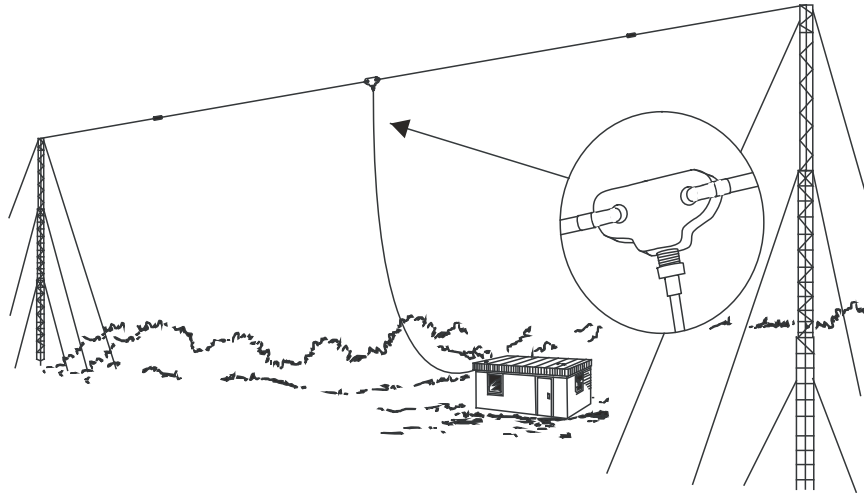

Dipole antennas should be mounted at least $\frac{1}{2}$ wavelength from the ground. Dipoles may be mounted either between two towers or in an inverted "V" configuration (requires only one mast). As a guide, when installing the masts, the length between insulators of a half wave wire dipole is $142/(\text{frequency of dipole in MHz})$ metres. To this an allowance should be made for extra insulators and halyards.

For example, a 3.7 MHz dipole - length between the insulators = $142/3.7$
=38.38 metres.

Wire dipoles supplied by Barrett are pre-cut to a specified frequency but have adjustable ends. These adjustable ends allow fine tuning for optimum VSWR during installation. To fine tune a dipole install the antenna in its final position and check the antenna VSWR. Should the VSWR be greater than 5:1 the antenna will require adjustment.

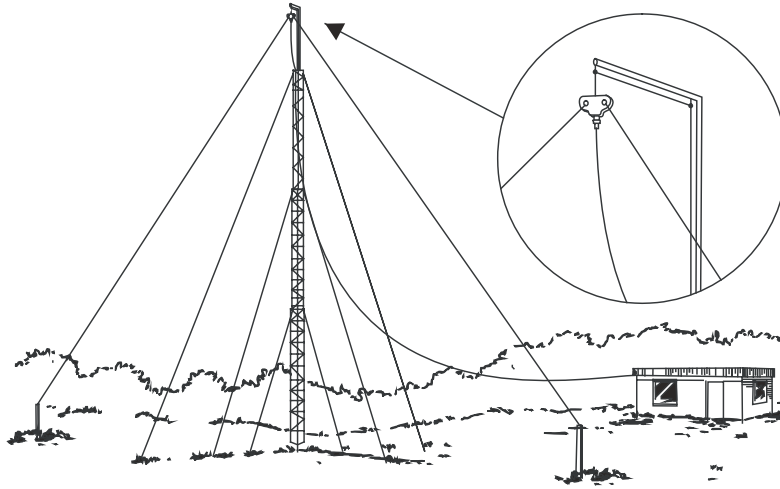

If a tunable transmitter is available, determine at what frequency the best VSWR is obtained. If this occurs at a frequency below the required frequency the dipole is too long, if it occurs on a frequency higher than the required frequency then the dipole is too short. Drop the dipole and adjust both ends by an equal amount and repeat the above sequence until an optimum VSWR is obtained. If a tunable transmitter is not available, use a method of trial and error shortening or lengthening the dipole ends, a little at a time, until optimum VSWR is obtained. Remember to always adjust each end by the same amount as the other every time.

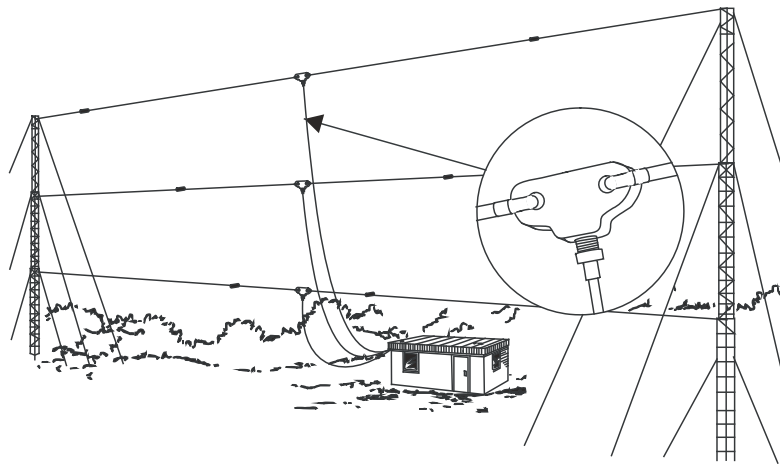

4017 Automatic Tuning Horizontal Dipole Antenna

The Barrett 4017 Automatic tuning horizontal dipole is designed for base station applications where space is at a premium but high performance is still required.

Mounting on a standard 50 mm pole, the Barrett Automatic tuning horizontal dipole can be mounted as close as 6 metres from the ground making it extremely easy to install. With a packed length of only 2.1 metres the antenna can be easily transported by air.

The tuner has a memory system that stores tuning information for each channel after an initial tune sequence with unlimited capacity.

Assembly fixtures are supplied to assist in mounting the antenna to an existing mast, tower or pole. Alternatively, a range of suitable masts can be supplied with the antenna.

The Barrett 4017 is supplied standard with a 30 metre composite control, RF cable and connectors to interface with Barrett 2050 transceivers.

Connection Details for a 4050 Transceiver and 4017 Automatic Tuning Horizontal Dipole Antenna

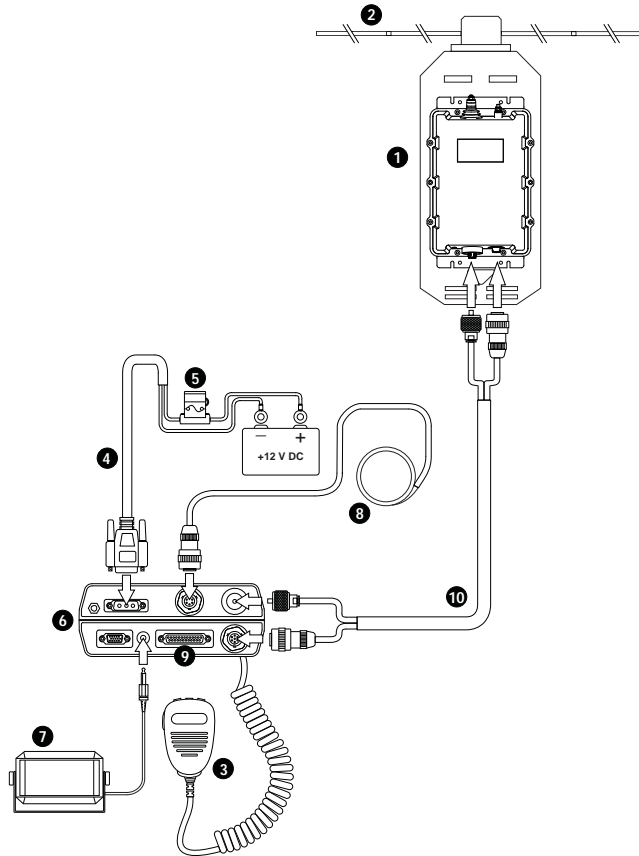

- 1 Barrett 4017 Automatic Tuning Horizontal Dipole Antenna
- 2 Horizontal Dipoles and Mounting Assembly
- 3 Microphone
- 4 6 metre power cable supplied with Transceiver
- 5 Fuse in-line with spare

- 6 4050 Transceiver
- 7 Extension speaker supplied with Transceiver (P/N BCA40015)
- 8 External GPS Receiver option (P/N BCA40009)
- 9 Auxiliary connector
- 10 Coaxial / Control Cable (P/N 4017-01-01)

911 Automatic Antenna Tuner for Base Station Installations

Antenna

Various antenna configurations, such as vertical whips, long wires and loops, can be used for base station installations, using the Barrett 911 automatic antenna tuner. However, the following points should be considered:

The antenna should be mounted as far away as possible from buildings, trees, vegetation and sources of electrical interference. If metallic masts or supports are used, arrange insulators to ensure the antenna is spaced at least two metres from the mast. Remember the radiating part of the antenna starts at the tuner. The location of the bottom portion of the antenna is very important.

Horizontal wire antennas have maximum radiation broadside to the antenna when the frequency is less than $\frac{1}{4}$ wavelength. Radiation is at a minimum at the end points of the antenna. Inverted "V" installation of horizontal antennas minimises the directivity and is recommended for omni-directional coverage.

High voltages are present on the antenna system. The antenna tuner and antenna should be located or protected so that there is no possibility of accidental contact.

Transceiver and Tuner Mounting

The Transceiver should be mounted in a suitable position allowing easy operator access. The antenna tuner should be mounted, preferably out of the weather, and as close to the ground (earth) point as possible. The interconnect cable supplied with the antenna tuner should be routed, away from other cables, back to the Transceiver and connected as indicated in the diagram. The maximum interconnect cable should be less than 25 metres.

Ground (Earth) System

The ground (earth) system is a key part of the overall antenna system and consequently the system operation. An inadequate ground system is the primary cause of poor performance and tuning problems. There is little point in installing the antenna unless a good ground system can be provided. In areas of good ground conductivity (i.e. ground always damp), an effective ground can be made through a grounding rod. This should be approximately three metres in length and should be installed as close to the tuner as possible. Several rods bonded together will improve the ground contact. In some cases metal water pipes may be used as a ground providing:

- The water pipe is close to the tuner and the water pipe enters the ground close to the tuner.
- There are no joints or couplings in the pipe that will increase the resistance path to ground.
- The water pipe enters soil with good conductivity.
- A low resistance joint is made with the water pipe.

Frequently the ground conductivity will not be sufficient to provide a satisfactory ground for the Barrett 911 tuner. This will almost certainly be the case in well drained sandy soils or on rock. In these cases, a counterpoise must be used as a ground system. This will also be the case in rooftop installations where no existing ground plate (such as metal roofing exists).

The number of radials required for an effective counterpoise depends on the soil quality, dampness and other factors which affect the conductivity of the soil. The more radials used, the better will be the performance of the antenna / ATU combination especially at lower frequencies. This manual suggests a minimum of 20 radials, but optimum performance at low frequencies is not guaranteed.

The radials of the counterpoise need only be of much thinner cable i.e. 5.48mm² (#1 #2 SWG) preferably copper wire. RG58 Coaxial cable may be used. At the base of the antenna, the radials all couple together at a common well bonded antenna ground point. The radials should be buried into the ground to a minimum of 200 mm depth.

Note: To accomplish reliable ATU tunes at frequencies below 5 MHz, it is not uncommon, with poor conductive soil conditions, to require up to 120 radials each of up to 70 m length, requiring thousands of metres of cable and a lot of trenching. This is impractical and is the reason we do NOT recommend Whip / ATU antenna for land based systems.

Electrical Checkout

After mechanical installation is complete, select the highest frequency to be used on the Transceiver. A directional watt-meter such as a Bird model 43 may be inserted in the coaxial transmission line between the Transceiver and the tuner, although the internal metering of the Barrett 4050 Transceiver is adequate. The tune mode on the Transceiver is then energised. Upon application of RF energy, the tuner should start to tune, indicated by the 'clattering' of the tuner relays. After a few seconds the relay noise will cease, the Transceiver should indicate a successful tune and the watt-meter, and front panel indication of the 4050 should show a low value reflected power consistent with a VSWR of better than 2:1. Now select the lowest desired frequency on the Transceiver and repeat the above procedure. The result should be the same, except that the tune cycle may take somewhat longer. If the above procedure does not give the results indicated, check that the antenna length and connections are correct and re-check all ground (earth) connections.

Note: When received, the Barrett 911 automatic antenna tuner memory system will usually not have any pre-stored tuning information appropriate to your installation. To allow the 911 to 'learn' its tuning information, simply proceed from one channel to the next allowing the normal tune cycle to take place. Each successful tune is 'memorised' so that when that channel is re-selected the tuner will almost instantaneously retune to that frequency.

Connection Details for a 4050 Transceiver and 911 Automatic Antenna Tuner in a Base Station Configuration

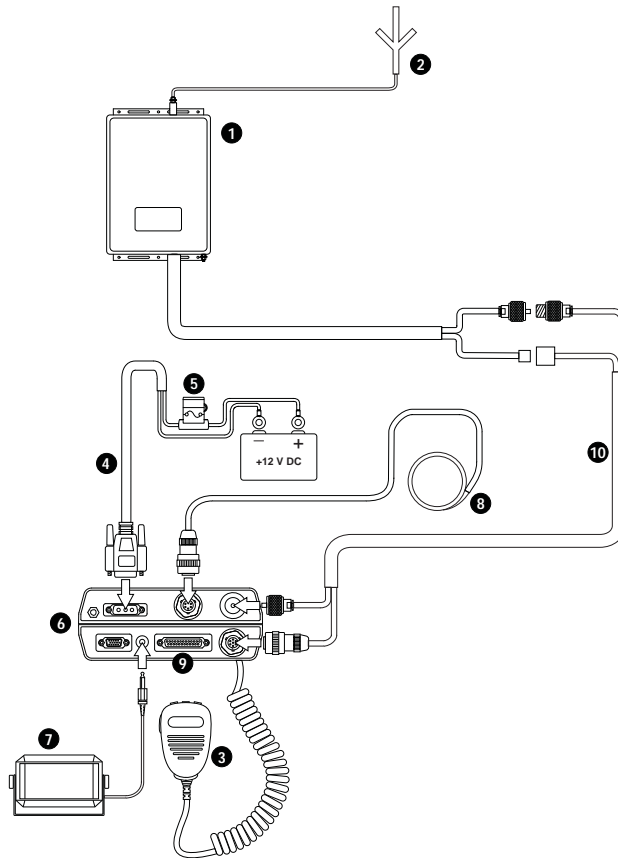

- ❶ Barrett 4011 automatic antenna tuner
- ❷ Antenna
- ❸ Microphone
- ❹ 6 metre power cable supplied with Transceiver
- ❺ Fuse in-line with spare

- ⑥ 4050 Transceiver
- ⑦ Extension speaker supplied with Transceiver (P/N BCA40015)
- ⑧ External GPS Receiver option (P/N BCA40009)
- ⑨ Auxiliary connector
- ⑩ Coaxial / Control Cable Extension (P/N BCA90055)

4011 Automatic Antenna Tuner for Base Station Installations

The Barrett 4011 automatic antenna tuner is designed for operation in both marine mobile and land base station installations.

Housed in a fully weatherproof enclosure the 4011 will tune long wire antennas effectively up to a length of 10 metres and wire loop antennas or whip antennas over a frequency range of 2 to 30 MHz. Tuning is rapid, typically less than one second the first time RF is applied, either whilst the operator is talking or when the "Tune" control is activated on the Transceiver.

The 4011 tuner features a memory facility that stores the configuration required to tune to a frequency. On any subsequent use of that frequency, the 4011 reconfigures to the stored settings in typically less than 130 milliseconds. Following initial tuning, the antennas VSWR is monitored. If any significant variation occurs, the 4011 will re-tune the antenna automatically.

The 4011 is supplied complete with coaxial / control cable having an overall length of 30 metres (P/N 4017-01-01). The cable is a composite design incorporating coaxial, power supply and control cables.

Connection Details for a 4050 Transceiver and 4011 Automatic Antenna Tuner in a Base Station Configuration

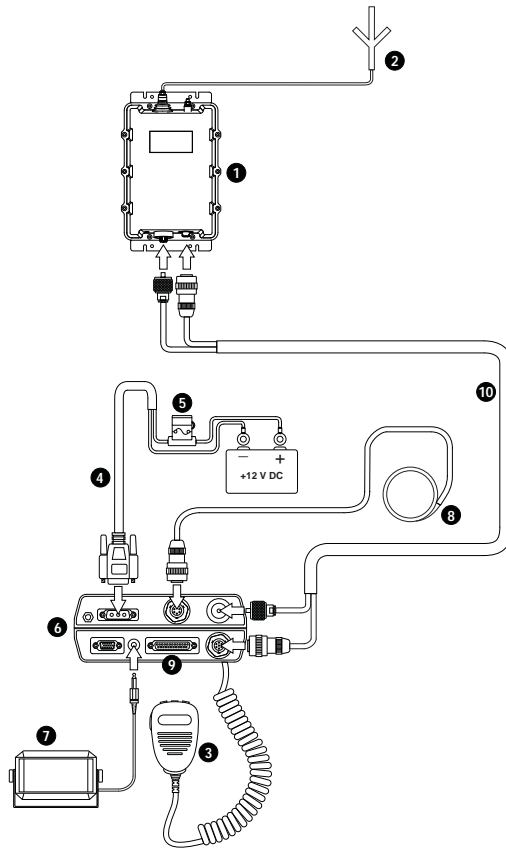

- ① Barrett 4011 automatic antenna tuner
- ② Antenna
- ③ Microphone
- ④ 6 metre power cable supplied with Transceiver
- ⑤ Fuse in-line with spare

BARRETT 4050 HF SDR TRANSCEIVER - OPERATING AND INSTALLATION MANUAL

- ⑥ 4050 Transceiver
- ⑦ Extension speaker supplied with Transceiver (P/N BCA40015)
- ⑧ External GPS Receiver option (P/N BCA40009)
- ⑨ Auxiliary connector
- ⑩ Coaxial / Control Cable Extension (P/N 4017-01-01)

Mobile Installations

Site Selection Recommendations

The following points must be considered when mounting the Transceiver.

Safety It is essential that the Transceiver be mounted in a place where it cannot cause injury to the occupants of the vehicle in the event of a motor vehicle accident.

For this reason overhead mounting is not generally recommended and "under dash" mounting must take into account the possibility of injuring the legs of front seat occupants.

Convenience The chosen position for the Transceiver or control head, (if a remote controlled model is used) should be one which allows convenient operation.

Positions which are often used are:

- On the transmission hump
- In place of the glove box
- Behind the seat
- Under the dash board (if safe).

Where a remote controlled Transceiver is used, only the control head need be mounted convenient to the operator. The Transceiver may be mounted under a seat, in the luggage compartment or any other out of the way place within the vehicle (which allows for sufficient cooling).

All equipment should be positioned in such a way that convenient access for maintenance is provided.

Strength It must be assumed that the vehicle will be used on rough roads and in many cases off road. Hence mounting of equipment must take into account the severe vibration and shock that can be expected.

Transceivers may only be mounted to structural components of the vehicle body and not on dress panels or plastic interior panels. In some cases, the area around the Transceiver mounting may need reinforcement.

Precautions should be taken to ensure fixing screws etc. cannot vibrate loose.

Air Circulation	Most Transceivers rely on air flow around cooling fins to dissipate heat generated by the transmitter. The mounting position must allow free airflow around these fins.
Obstruction	The installation of a Transceiver into a vehicle should not inhibit the normal use of the vehicle. Before finally selecting equipment positions, check that normal operation of steering, foot pedals, gear change, hand brake etc. are not impeded, and that heater or air-conditioning outlets, glove box and doors are not obstructed. Always check that the drilling of mounting screw holes will not damage electrical wiring, heater hoses or hydraulic lines.

Power Wiring

Connect the red positive and black negative wires from the Transceiver power cable to the positive and negative terminal of the battery. Do not connect to the ignition switch or internal fuse panels as vehicle wiring to these points is of insufficient current capacity, causing voltage drop and possible noise interference.

- Route the power cable away from high tension ignition wiring.
- Secure the power cable, either to other wiring or the vehicle body, with suitable cable ties.
- Where wiring passes through bulkheads, provide appropriate protection to prevent insulation being damaged.
- If an isolation switch is fitted between the battery's negative terminal and the vehicle chassis then it is important to connect the radio's negative supply cable to the chassis side of the isolation switch.

Earthing

Ideally the radio should be mounted as close as possible to the antenna with a common earthing point being used for both the antenna's earth connection and the radio's earth connection.

Antenna

In any radio system an effective antenna installation is essential. Because of the need to reduce the size of HF antennas so that they can be fitted to a vehicle, mobile antenna bandwidth becomes quite narrow and hence tuning is critical. In most cases the only tuning adjustment that can be effected is adjustment to position. Particular attention must be given to the antenna position if satisfactory performance is to be obtained. Refer to the instructions supplied with the antenna you have selected.

Antenna Mounting

The antenna mounting must provide a strong secure anchorage for the base of the antenna. To obtain maximum radiation, the antenna base must be well bonded electrically to the vehicle chassis. Paint, dirt, rust, etc. should be removed from the respective fixing points. The mounting point must provide a low resistance electrical path to the main vehicle metallic structure.

Antenna Feed Cables

Antenna feed cables should be run (as far as possible) away from other vehicle wiring and especially away from ignition high tension wiring. Where passing through body panels or internal bulkheads, grommets must be used to protect the cables. Water-proof connectors must be used when they are outside the vehicle.

Voltage Standing Wave Ratio (VSWR)

After installation it is recommended that the VSWR of the antenna should be measured for each channel. The instructions supplied with each antenna will detail this operation.

Noise Suppression

Please note that some newer fuel injected engines emit very strong EMI (Electromagnetic interference) noise levels across the HF radio band, which is near impossible to suppress. For these installations, moving the position of the antenna to another position on the vehicle may reduce the noise effect but full elimination of noise during engine running may never be achieved. Please note that this is not unique to the Barrett 4050 radio as all radio makes will suffer similarly from the effects of this noise under these conditions.

Noise generated by motor or electrical accessories on the vehicle may cause objectionable interference to the received signal. This noise enters the receiver either by means of the battery leads or the antenna system. Providing that the recommendations concerning battery wiring given earlier in this manual are followed, noise injected via the battery lead is unlikely to be significant. Most noise problems result from pick-up by the antenna. Practical cures involve either preventing the noise from being generated or minimising it from being radiated by the wiring connected to the noise source.

Interference Suppression Kit

(Barrett P/N BCA20008) is available to assist in noise suppression and contains filters, suppressing capacitors, earth straps and fitting instructions.

The techniques involved in noise suppression include re-routing of wiring, screening and the use of filters. It is also necessary to maintain all electrical equipment in good working order as worn brushes, loose connections and the like, will increase the amount of noise generated.

Before attempting to cure a noise problem, the source (or sources) of noise must be identified. Ideally, there should be no difference between background noise in the receiver with motor and accessories on and that with motor and accessories off.

If a detectable difference does exist, turn off all accessories one by one until a change in noise results. Continue, noting each contributing unit until there is no detectable difference from the "all off" noise level. (For accessories such as alternator, motors, instruments etc. a wire or drive belt may have to be temporarily removed for this assessment.) After identifying each noise source, they can be worked on one at a time until an acceptable level of suppression is achieved.

Another approach to this problem is to remove or disconnect all possible sources of noise then replace and suppress them in turn.

Some suggestions for suppressing particular noise sources follow:

BARRETT 4050 HF SDR TRANSCEIVER - OPERATING AND INSTALLATION MANUAL

Ignition Systems	All high tension wiring from the ignition coil through to the spark plugs should be kept as short as practicable, clean, and as close to the engine block as possible. The cable should be an impregnated neoprene resistive type and the coil must be either mounted on, or immediately adjacent to, the engine block. The low tension wire from the coil to the distributor contact breaker points must be as short as possible, and not included with other wires in a harness or loom. This wire must be shielded if more than 300 mm long. Twin flex or 'figure eight' cable provides a suitable shield when connected in lieu of the original wire. This method is useful for shielding other wires suspected of radiating noise. Do not ignore the wire to an electric tachometer if one is fitted.
Coil to Battery Wiring	A low pass filter such as that supplied in the interference suppression kit or similar should be fitted at the coil end of this wire. The earth connection of the filter should be short and well-bonded to the coil body.
Alternator / Generator to Battery Wiring	A low pass filter such as that supplied in the interference suppression kit or similar should be fitted to the main battery lead at the alternator. The filter must be rated for the maximum current available from the charging system. The earth lug of the filter should be attached to the alternator body or the engine block.
Alternator to Regulator Control Wire (Generator Field Wire)	This wire carries switching pulses that often contribute noise to the receiver. Suppression using capacitors or filters must not be attempted since damage to the regulator may result. Separate the wire from all other wiring, keep it as short as possible and, if longer than about 300 mm it should be shielded as described above.
Other Regulator Wires	These are normally adequately suppressed using good low-inductance bypass capacitors. To be effective, these capacitors must connect to the wires to be suppressed and to chassis with very short leads. For this reason, the 'pigtail' style of suppressor capacitor often used with MF broadcast receivers is generally ineffective at HF.
Electric Motors (windscreen wipers, fans etc.)	Small electric motors can usually be suppressed with good low inductance bypass capacitors.

Engine Instrumentation Certain types of oil-pressure sensors and voltage regulators used in instrument systems contain a vibrating or thermal cycling contact. These devices can only be suppressed by isolating and screening or wiring in the same way as described for the alternator to regulator control wire. Disc ceramic capacitors with short leads (protected with insulating sleeving) are frequently useful but to prevent damage to instrument contacts, where the use of bypass capacitors is attempted, values larger than 1 nF should not be used.

General Noise Suppression Tips

When searching for sources of noise, some of their characteristics can be helpful in identification:

- Petrol engine ignition noise and contact breaker noise is a sharp staccato 'plop' varying with engine speed. It is only with this class of noise that the impulse noise limiter incorporated within some Transceivers is effective.
- Noise from other sources generally has a more 'mushy' sound. That from the alternator / generator may only be troublesome over a limited range of engine speed and can also be influenced by the state of charge of the battery.
- The noise from instrument regulators may depend on the battery voltage, the reading of the instrument and the length of time the system has been switched on. For this reason, the search for noise sources must be done thoroughly to prevent noise from apparently reappearing after the installation has been completed.
- Electric motors generate a 'whining' sound. Do not forget to check windscreen wipers, electric fuel pumps, heater and air conditioning fans and other motors which operate only on an intermittent basis.

2019 Automatic Tuning Mobile HF Antenna

(Barrett P/N BC201900)

The Barrett 2019 automatic tuning mobile HF antenna plugs directly into the rear of a 4050 Transceiver using the cables supplied.

Important: 4050 Transceivers must have the 2019 antenna option set during programming.

Mounting the Barrett 2019 Automatic Tuning Mobile HF Antenna

The Barrett 2019 antenna should be mounted in positions similar to those illustrated in the diagrams on the following pages. Select a position free from excessive vibration. A bracket, fabricated to withstand the forces and vibration that can be expected during off-road driving, should be used to mount the antenna to the vehicle. When locating the mounting position for the antenna ensure that the antenna body, when flexing on its vibration mount, cannot come into contact with other parts of the vehicle. The antenna should be mounted as far from surrounding objects on the vehicle as possible.

The antenna is supplied standard with two sections (Barrett P/N: BCA201901), a tapered black spring (Barrett P/N: BCA201903), an antenna installation guide and a pre-terminated six metre control cable to suit the Barrett 2019 antenna to Transceiver. A six metre (Barrett P/N: BCA201904) or ten metre (Barrett P/N: BCA201905) extension cable for the control cable is also available.

The control cable should be routed into either the engine compartment or boot (trunk) of the vehicle. If the joint between the antenna control cable and the extension cable is in an exposed position, a butyl rubber self amalgamating tape should be used to seal the joint. Do not wrap this joint if it cannot be made completely water tight as water will collect in the joint and cause it to corrode.

A good earth (ground) to the main body of the vehicle is essential for efficient operation of the antenna. To achieve this clean all joints to bare metal and use copper braid earth straps if any non-metallic joints are encountered.

After mounting the main body of the antenna, screw the black base spring onto the antenna body followed by the whip section.

Important Information

It is ESSENTIAL to maintain the minimum clearances between the antenna and surrounding metal work as indicated in the diagrams. FAILURE TO MAINTAIN THESE CLEARANCES WILL NOT ONLY REDUCE THE EFFICIENCY OF THE BARRETT 2019 AUTOMATIC TUNING MOBILE HF ANTENNA BUT MAY ALSO LEAD TO INTERNAL RF ARCING AND FAILURE.

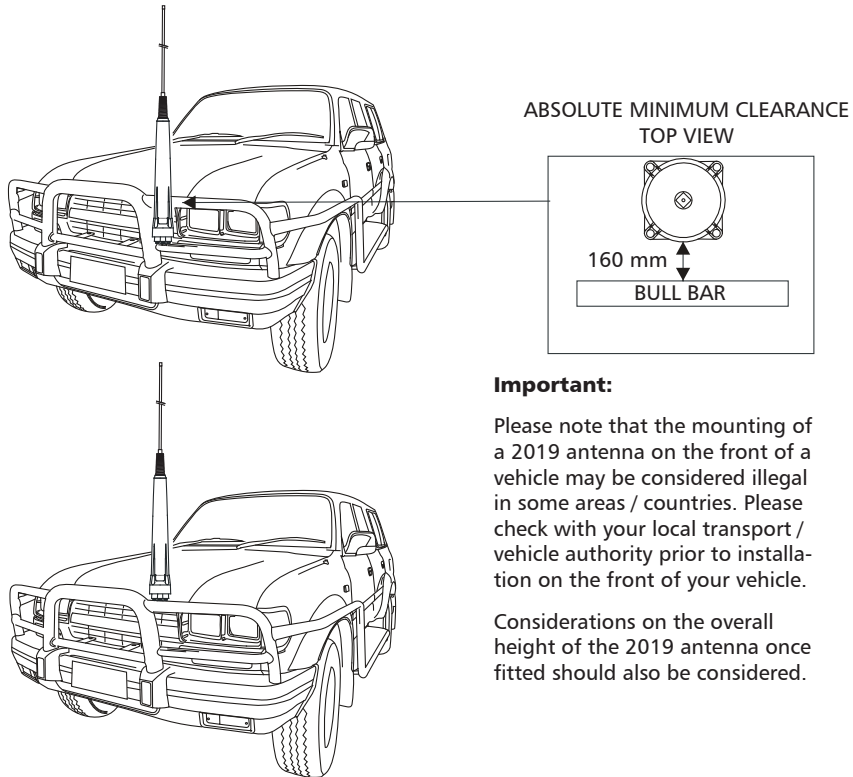

Important:

Please note that the mounting of a 2019 antenna on the front of a vehicle may be considered illegal in some areas / countries. Please check with your local transport / vehicle authority prior to installation on the front of your vehicle.

Considerations on the overall height of the 2019 antenna once fitted should also be considered.

BARRETT 4050 HF SDR TRANSCEIVER - OPERATING AND INSTALLATION MANUAL

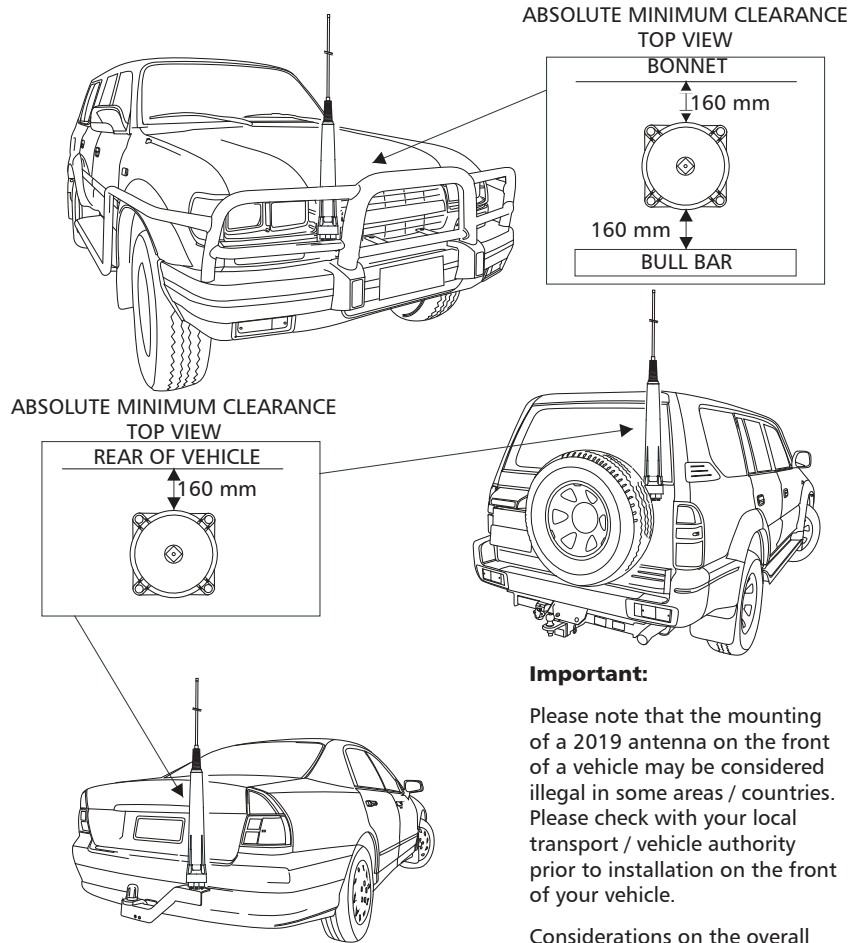

Caution:- Whilst the 2019 automatic tuning mobile HF antenna is designed to withstand vibration to military specifications on tyred vehicles, some mounting positions on large prime-movers, particularly front mounted bull bars, are subject to vibration that far exceeds this specification. Do not mount the 2019 antenna in positions such as these as damage to the antenna may result.

Antenna Assembly

Mounting the Base Spring

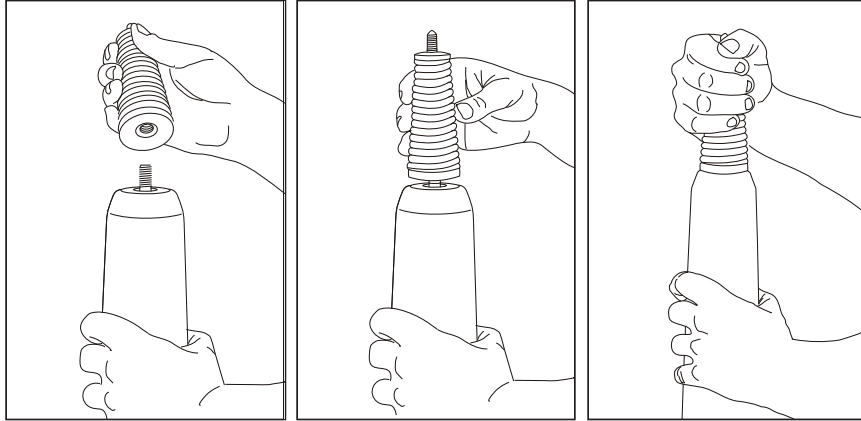

The base spring should only ever be hand tightened, if a tool is used it may damage the spring base.

Mounting the Whip Sections

To mount the whip section it is recommended that only one section of the whip is screwed onto the antenna at a time. The whip section should be hand tightened fully then a suitable tool (i.e. a spanner) can be used to tighten the section a further 10 to 20 degrees clockwise while holding the antenna body with a free hand.

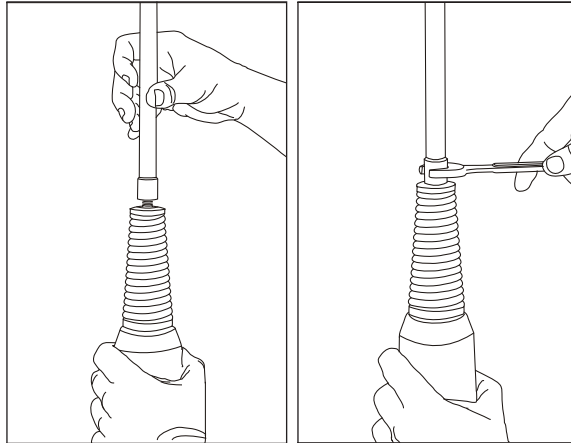

To mount two whip sections together, the unattached whip section should be hand tightened fully then a suitable tool (i.e. a spanner) can be used to tighten the section a further 10 to 20 degrees clockwise while holding the already screwed on whip section with a free hand.

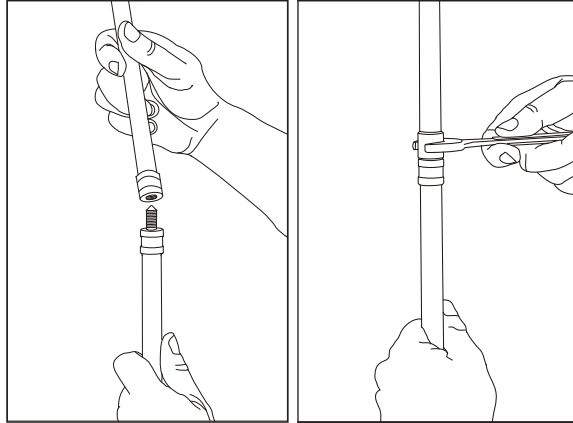

Connection Details for a 4050 Transceiver with Mobile Pack and 2019 Automatic Tuning Mobile HF Antenna

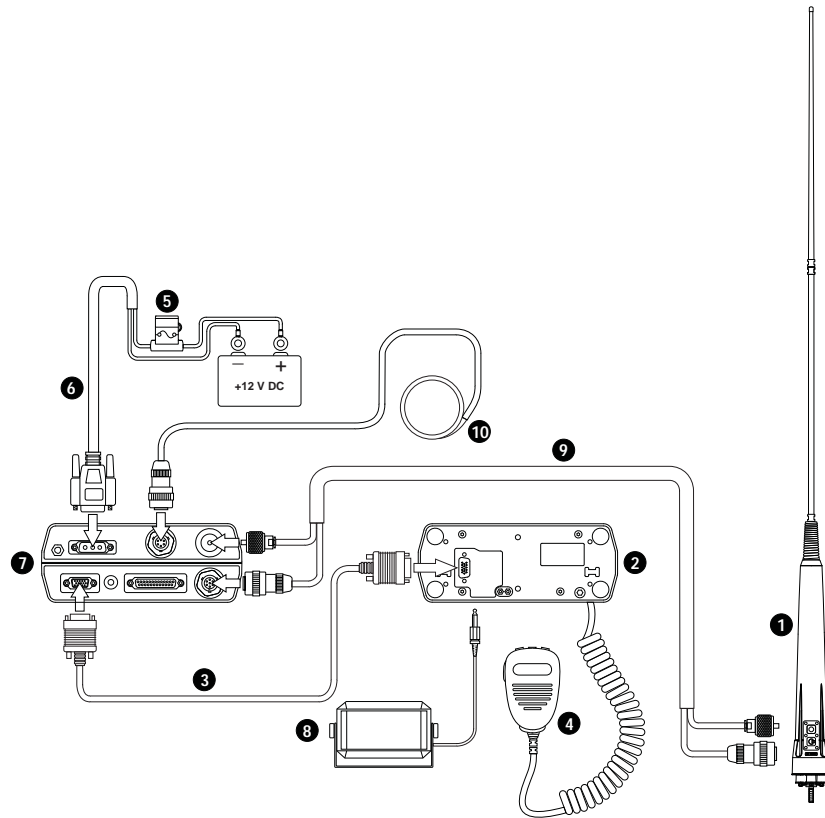

- ① Barrett 2019 Automatic Tuning Mobile HF Antenna
- ② 4050 control head
- ③ 6 m Control Cable (P/N SA 45100)
- ④ Microphone
- ⑤ Fuse in-line with spare

- 6 6 metre power cable supplied with Transceiver
- 7 4050 Transceiver
- 8 Extension speaker supplied with 4050 Transceiver (P/N BCA40015)
- 9 Coaxial / Control Cable Extension
- 10 External GPS Receiver option (P/N BCA40009)

Testing the Barrett 2019 Automatic Tuning Mobile HF Antenna

To test the Barrett 2019 antenna, first select the lowest transmit frequency in the Transceiver and tap **Tune**. The display should show the word "Tuning" for a few seconds, followed briefly by "Tune Passed" and an indication of the measured VSWR (Voltage Standing Wave Ratio) value. Check this reading against the VSWR meter.

Repeat the above test on the highest frequency in the Transceiver and on a selection of frequencies in between at approximately 2 MHz intervals. If the tune passes at all times, the Barrett 2019 antenna is working correctly. The Barrett 2019 antenna tunes to maximise whip current, not minimise VSWR, but the displayed VSWR value should generally be between 1.0:1 and 2.0:1. However, if the display shows "Autotune Fail" accompanied by low pitched beeps at any point, the Barrett 2019 antenna has failed to tune. Confirm the "Antenna Type" is selected to "2019 Mobile Ant" in the Transceiver Menu Settings > IO > Antenna Type setting (page 98). Check all cables are correctly connected, check the earth cable from the base of the Barrett 2019 antenna has a good connection to the vehicle body (not chassis or battery), check the whip fitted is not faulty or incorrect and move the vehicle if the Barrett 2019 antenna is close to any metal fences, buildings etc. If the problem cannot be resolved, contact your dealer or Barrett Service Department for advice.

914 Series Manual Tap Whip Antenna

(Barrett P/N BC91401 to BC91424)

Installation

914 series manual tapped whip antennas are mounted on vehicles using a heavy duty base and spring (Barrett P/N BCA91400). The whip should be mounted on the vehicle in positions such as those illustrated in the diagrams below. A bracket, fabricated to withstand the forces and vibration that can be expected during off-road driving, should be used to mount the antenna base and spring to the vehicle. When locating the mounting position for the antenna, the ring located above the label at the bottom of the whip should be level with the surrounding ground plane, e.g. the bonnet of the vehicle or the roof of the vehicle. Ensure that the mounting bolt on the base and spring is electrically bonded to the chassis of the vehicle via a very low resistance path, i.e. clean all joints to bare metal and use braid earth straps if any non-metal joints are encountered. Use only good quality coaxial cable and water proof UHF connectors (such as those supplied by Barrett Communications).

Do not use PL-259 UHF connectors.

When running the coaxial cable from the antenna to the Transceiver, avoid sharp corners and heat such as that generated by the manifold of the engine. After installing the antenna check the antenna VSWR on each channel. Generally if the antenna has been mounted in the positions as illustrated, the VSWR will be less than 1.6:1 and no adjustment is necessary. If the VSWR is not lower than 2:1 the antenna to ground capacitance in that installation is probably outside of the design range of the factory set tuning. Consideration may be given to retuning the whip if the VSWR is so high as to cause the transmitter ALC system to begin to reduce power (to protect the transmitter).

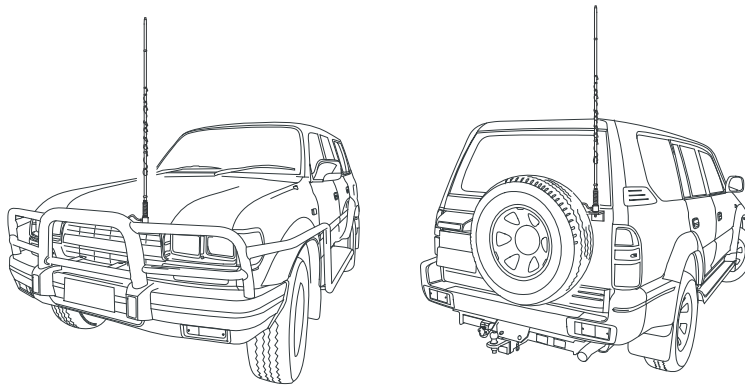

For each frequency which will not tune correctly you will need to determine whether the tuning is high or low in frequency. Generally any frequencies which will not tune will always be out the same way. When the antenna is manufactured, most frequencies are deliberately made on the low frequency side and adjusted upwards by the placement of "tuning rings". Tuning rings are single short circuit rings of 20 amp fuse wire placed on the windings of an individual part of the antenna. A tuning ring inductively raises the frequency of the section of antenna over which it is placed.

It must be understood that the tuning of an antenna on a particular vehicle or installation may not hold for other vehicles or installations. To determine whether any particular frequency tap is high or low, hold the tune key down on the relevant frequency and observe the VSWR on a suitable meter. Get an assistant to slowly move his outstretched arm closer to the antenna tap in use.

If the VSWR gets better, then the antenna is too high in frequency. This indicates that there is insufficient antenna to ground capacity. Usually this happens when the antenna is mounted too far away from the body of a vehicle. Either re-site the antenna closer to the vehicle or remove any tuning rings which are already on the antenna.

If the VSWR gets worse when following the above procedure, then too much capacity is already present. This is frequently encountered when mounting the antenna too low on a vehicle bumper bar or when mounting close to bodywork as in cab-over type vehicles. In this case, either re-site the antenna further away or add extra tuning rings to the frequency sections affected until a suitable VSWR is obtained.



If the highest frequency on the whip requires adjustment, initially place the tuning ring here and slowly move upwards until a satisfactory SWR is obtained.

If the factory tuning ring is not fitted and the highest frequency on the whip requires adjustment, initially place the tuning ring here and move slowly upward until a satisfactory SWR is obtained.

If ONLY the lowest frequency requires adjustment, initially place the tuning ring here and slowly move upwards until a satisfactory SWR is obtained.

Note: Truck cab-over installations usually produce distorted radiation patterns even when the VSWR looks good.

When tuning is complete, any new rings added should be coated with epoxy resin to secure and protect the ring from damage. Five minute quick setting type epoxy is suitable. If rings need to be removed they may be cut off using a sharp pair of side cutters. Take care not to cut into the body of the antenna.

Note: If the wander lead is damaged or lost and requires replacing, the number on the first tap indicates the length of the replacement wander lead required.

Example: Wl-60 indicates the length of the wander lead was 60cm. When making a replacement wander lead ensure it is made to this length to obtain optimum performance.

Operation Instructions

The 914 manual tapped whip antenna should now be screwed into the base and spring mounted on the front of the vehicle.

The operation frequency being used on the Transceiver should now be selected on the antenna. This is accomplished with the supplied jumper lead as indicated in the diagram below and the following example (Note: this is an example only and your antenna will be manufactured with different frequency taps.)

The 914 manual tapped whip antenna used in the example has the following frequencies:

Channel 1	4030 kHz	Channel 2	4760 kHz
Channel 3	5190 kHz	Channel 4	5254 kHz
Channel 5	7180 kHz	Channel 6	8199 kHz
Channel 7	9134 kHz	Channel 8	9145 kHz
Channel 9	10567 kHz	Channel 10	14567 kHz

When using Channel 1, frequency 4030 kHz, the jumper lead should be removed from the bottom antenna socket and stored in the vehicle.

On all other channels the jumper lead is required:

For Channel 2, frequency 4760 kHz, the jumper is plugged into the bottom socket then wound tightly around the antenna and the other end plugged into the socket marked 4760.

For Channel 3, frequency 5190 kHz, the jumper is plugged into the bottom socket then wound tightly around the antenna and the other end plugged into the socket marked 5190.

And so on, to Channel 10.

The illustration shows a 10 frequency 914 manual tapped whip antenna with the highest frequency being selected.

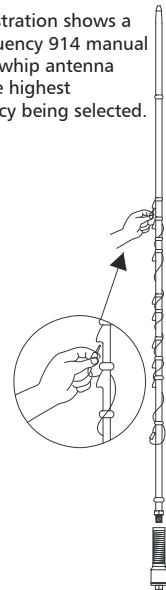

Note: It is important for correct operation of the whip antenna to have the right frequency tap selected as indicated above and that the jumper lead is wrapped tightly around the antenna between sockets.

Connection Details for a 4050 Transceiver with Mobile Pack and 914 Manual Tapped Mobile Antenna

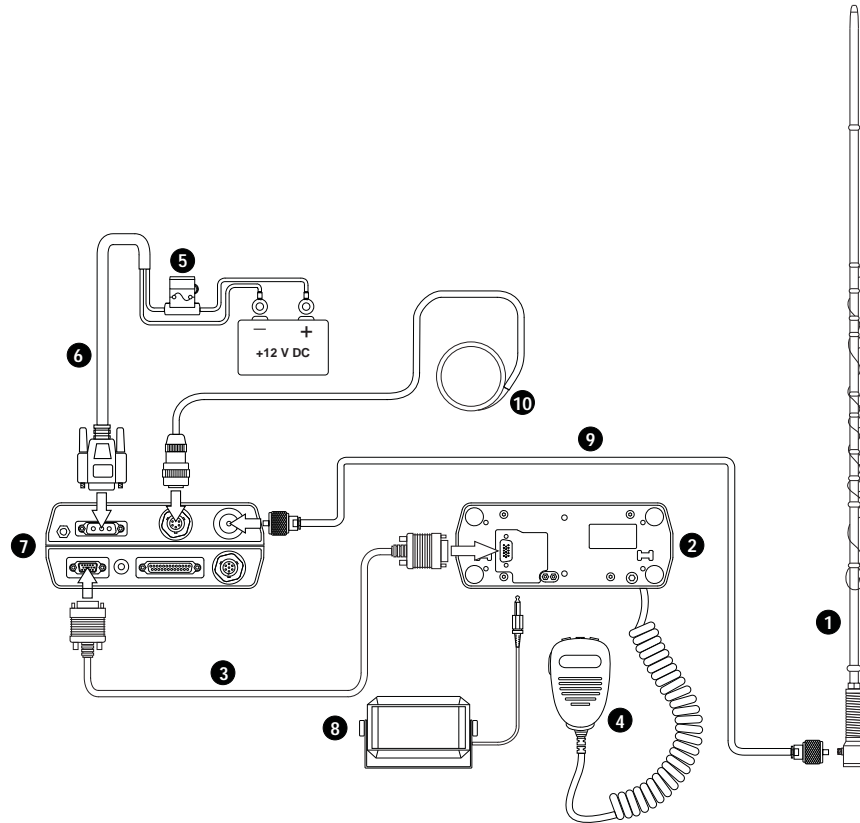

- ① Barrett 914 Manual tapped whip antenna
- ② 4050 control head
- ③ 6 m control cable (P/N SA 45100)

- 4 Microphone
- 5 Fuse in-line with spare
- 6 6 metre power cable supplied with Transceiver
- 7 4050 Transceiver
- 8 Extension speaker supplied with 4050 Transceiver (P/N BCA40015)
- 9 6 metre control cable (P/N SA 45100)
- 10 External GPS Receiver option (P/N BCA40009)

2018 Mobile Magnetic Loop Antenna

Connection Details for a 4050 Transceiver with Mobile Pack and a 2018 Mobile Magnetic Loop Antenna

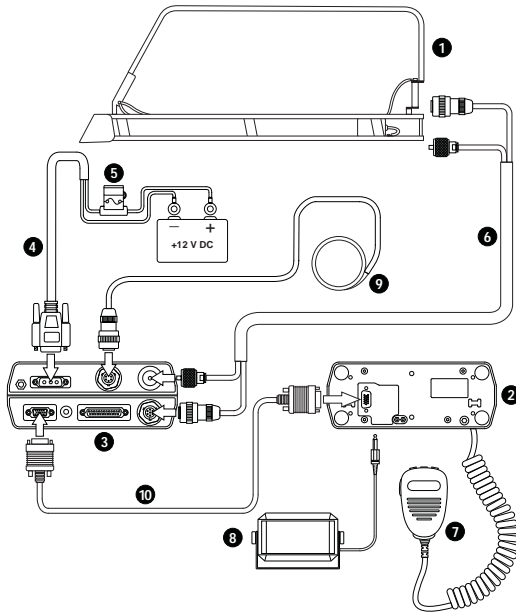

- 1 Mobile Magnetic Loop Antenna (P/N BC201801)
- 2 4050 Control Head
- 3 4050 Transceiver
- 4 DC Power Cable (P/N BCA40006)
- 5 Fuse in-line with spare
- 6 Control & Coaxial Cable 6m (P/N BCA201904)
- 7 Microphone (P/N MI-45001)
- 8 Loudspeaker (P/N BCA40015)
- 9 External GPS Receiver option (P/N BCA40009)
- 10 6 m Control Cable (P/N SA 45100)

Marine Installations

The Barrett 911 automatic antenna tuner is designed for use in land base station and maritime HF services. Primarily designed for operation with end-fed unbalanced antennas such as whips and long wires, the tuner is built in a waterproof impact resistant, moulded ABS plastic enclosure.

Antenna Selection

The 911 automatic antenna tuner will operate into almost any end-fed antenna with a length exceeding 2.5 metres, providing an effective ground (earth) is used. The antenna efficiency will be proportional to the length of the antenna and will be maximum when the length of the antenna approaches $\frac{1}{4}$ wavelength. It is advisable to limit the wire antenna to $\frac{1}{4}$ or $\frac{3}{4}$ wavelength at the highest frequency to be used.

Antenna

On sailing vessels the antenna can either be an insulated backstay or a whip antenna mounted vertically, usually on the stern. Best performance will be achieved by using an insulated backstay as the radiating length will be longer than that available when using a whip. The top insulator on the backstay should be approximately 300 mm from the mast and the bottom insulator should be at eye level above the deck. The distance between insulators should be greater than 10 metres and less than 35 metres. A whip antenna is generally used on small to medium sized power vessels. There are different length whips to suit the vessel length.

Transceiver and Tuner Mounting

Select a suitable position in the vessel to mount the Transceiver. It should be a position that is out of the weather and easily accessible to the operator, whilst as close as practical to the 13.8 V DC power source. Mount the Transceiver to a solid fixing point using the mounting cradle. Make sure there is sufficient space at the rear of the Transceiver to connect the power and antenna cables.

The antenna tuner should be mounted as close to the antenna feed point as possible. In metal vessels the length of the feeder from the antenna tuner to the feed-through insulator, inside the vessel, should be kept less than 1 metre.

The antenna feed cable should be a suitable high voltage cable. Care should be taken to avoid sharp points when terminating the cable to prevent corona discharges.

The interconnect cable supplied with the antenna tuner should be routed away from other cables back to the Transceiver and connected as indicated in the diagram overleaf.

Ground (Earth) System

The ground (earth) system is a key part of the overall antenna system and consequently the system operation. An inadequate ground system is the primary cause of poor performance and tuning problems. There is little point in installing the antenna unless a good ground system can be provided.

Metal hulled vessels provide an almost perfect ground. The tuner ground terminal should be connected directly to the hull using the shortest possible ground strap. The point of connection to the hull should be prepared so that it is free of paint and rust to ensure a good contact area with minimum electrical resistance.

Wooden or fibreglass vessels present more of a problem to ground. Ideally the vessel should be fitted with an external copper ground sheet, connected to the interior of the vessel by suitable stud or an earth plate ("E" plate Barrett P/N BCA91700)

If the vessel is yet to be constructed, then in the case of fibreglass vessels a thin copper sheet with an area of not less than 4 square metres should be moulded into the hull during lamination. A suitable heavy strap should be connected to the sheet and left free for earth connection.

Should neither of these methods be available it will be necessary to bond as many large metallic objects, such as the engine and propeller shaft, together to form a ground.

Whichever method is used the ground run from the ground system to the antenna tuner should be as short as possible and use copper strap at least 50 mm wide (wider if available). Consideration must always be given to the problem of electrolysis. Severe structural damage may occur if electrolysis is present.

Corrosion

All connections in marine situations are subject to corrosion and oxidation. To minimise this all joints should be cleaned and have silicon grease applied before assembly. Under severe conditions joints should be protected with self vulcanising rubber tape.

Electrical Checkout

After mechanical installation is complete, select the highest frequency to be used on the Transceiver. A directional watt-meter such as a Bird Model 43 should be inserted in the coaxial transmission line between the Transceiver and the tuner. The tune mode on the Transceiver is then energised (refer to the Transceiver user manual). Upon application of RF energy, the tuner should start to tune, indicated by the 'clattering' of the tuner relays. After a few seconds the relay noise will cease. The Transceiver should indicate a successful tune and the watt-meter reflected power should indicate a low value consistent with a VSWR of better than 2:1. If the cover of the tuner is removed, the PCB mounted 'tuned' LED should be illuminated. Now select the lowest desired frequency on the Transceiver and repeat the above procedure. The result should be the same, except that the tune cycle may take longer. If the above procedure does not give the results as indicated, check that the antenna length and connections are correct and re-check all ground (earth) connections.

BARRETT 4050 HF SDR TRANSCEIVER - OPERATING AND INSTALLATION MANUAL

Note: When received, the Barrett 911 automatic antenna tuner memory system will usually not have any pre-stored tuning information appropriate to your installation. To allow the 911 to 'learn' its tuning information simply proceed from one channel to the next allowing the normal tune cycle to take place. Each successful tune is 'memorised' so that when that channel is re-selected, the tuner will almost instantaneously retune to that frequency.

Connection Details For a 4050 Transceiver and 911 Automatic Antenna Tuner in a Marine Installation

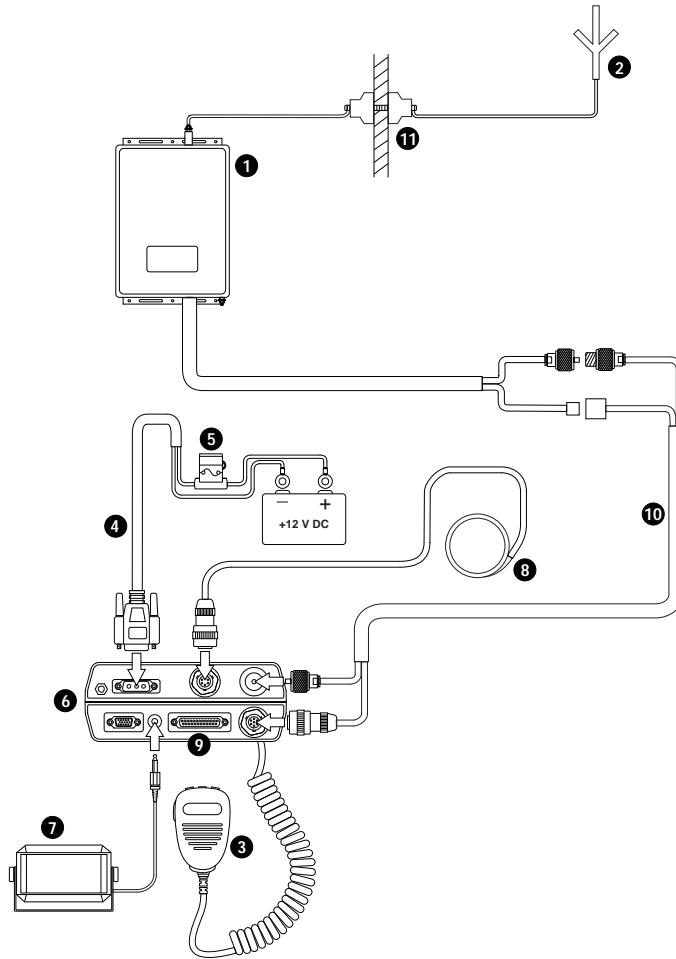

BARRETT 4050 HF SDR TRANSCEIVER - OPERATING AND INSTALLATION MANUAL

- ① Barrett 911 automatic antenna tuner
- ② Antenna
- ③ Microphone
- ④ 6 metre power cable supplied with Transceiver
- ⑤ Fuse in-line with spare
- ⑥ 4050 Transceiver body
- ⑦ Extension speaker supplied with Transceiver (P/N BCA40015)
- ⑧ External GPS Receiver option (P/N BCA40009)
- ⑨ Auxiliary Connector
- ⑩ Coaxial / Control Cable Extension (P/N BCA90055)
- ⑪ Feed Through Insulator

Overview of HF Operation

HF (High Frequency) is the radio spectrum with frequencies between 1.6 and 30 MHz. Within this radio spectrum an efficient form of transmitter modulation, SSB (Single Side Band), is used. This, combined with the use of the ionosphere - a layer of ionisation gases that resides between 100 and 700 km above the earth's surface, provides efficient, cost effective communications over short, medium and long distances - without the need for expensive re-transmission devices, such as the VHF or UHF repeaters or satellites, all of which have ongoing operational costs and a reliance on a physical infrastructure.

In many remote areas, HF / SSB is the only form of communication possible.

HF Propagation

When HF / SSB radio waves are generated by the Transceiver there are usually two components:

- The ground-wave, which travels directly from the transmitting antenna to the receiving antenna following the contours of the earth.
- The sky-wave, which travels upward and at an angle from the antenna, until it reaches the ionosphere (an ionised layer high above the earth's surface), and is then refracted back down to earth, to the receiving antenna.

Generally speaking, ground-wave is used to communicate over shorter distances usually less than 50 km. Because ground-wave follows the contours of the earth, it is affected by the type of terrain it passes over. Ground wave is rapidly reduced in level when it passes over heavily forested areas or mountainous terrain.

Sky-wave is used to communicate reliably over medium to long distances up to 3,000 km. Whilst the nature of sky-wave propagation means it is not affected by the type of terrain as in ground-waves, it is affected by factors involving the ionosphere as described below.

Radio Wave Propagation

The following illustrations show the characteristics of ground-wave and sky-wave propagation during day and night time. In each illustration the height of the ionosphere above the ground is shown.

In both illustrations Station A communicates with Stations B, C and D. Propagation from Station A to B is by ground-wave. The diagrams illustrate that the ground-wave is not affected by the time of day and the height of the ionosphere above the ground.

Propagation from Station A to C and D, is by sky-wave and as the diagrams illustrate, the sky-wave is significantly affected by the time of day and the height of the ionosphere above the ground.

Under each diagram there are recommended working frequencies listed. Please note that these will vary according to time of year and other factors. They are intended only as a guide and are subject to change.

Day

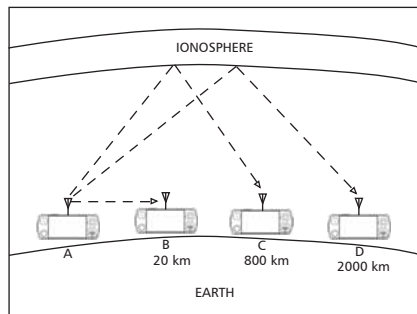

The sun is higher
 The ionosphere is higher
 The best frequency to use is higher.
 A to B - Possible optimum working frequency is 3 MHz
 A to C - Possible optimum working frequency is between 7 - 9 MHz
 A to D - Possible optimum working frequency is between 13 - 16 MHz

Night

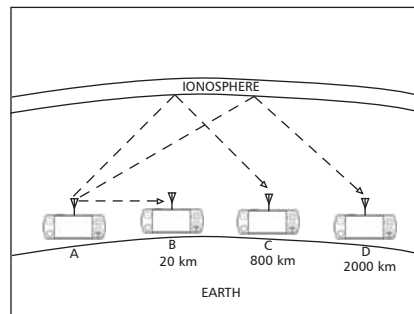

The sun is lower
 The ionosphere is lower
 The best frequency to use is lower.
 A to B - Possible optimum working frequency is 3 MHz
 A to C - Possible optimum working frequency is between 5 - 7 MHz
 A to D - Possible optimum working frequency is between 9 - 12 MHz

Factors Which Affect HF / SSB Communications

There are a number of different factors which will affect the success of communications via HF / SSB radio. These are outlined below:

Frequency Selection

Frequency selection is perhaps the most important factor that will determine the success of your HF / SSB communications.

Generally speaking the greater the distance over which you want to communicate, the higher the frequency you should use.

Beacon Call, a Selcall (Selective Call) function built into the Barrett Transceiver, makes finding the correct frequency to use easy. A Beacon Call is based on the Network Transceivers all having a selection of frequencies that will accommodate most ionospheric conditions. When in standby, the network Transceivers scan these frequencies waiting for a call (Selcall or Beacon Call) from another Transceiver. The Transceiver wishing to check for the best frequency to operate on sends a Beacon Call to the station to be contacted. If the call to the other station is successful, a revertive tone from the station being called will be heard, indicating the channel selected was suitable for the ionospheric conditions prevailing. If the revertive tone is not heard or is very weak, another channel may be tried until a revertive tone of satisfactory signal strength is heard.

(Refer to Beacon Calls on page 32 for more details.)

Time of Day

As a rule, the higher the sun, the higher the frequency that should be used. This means that you will generally use a low frequency to communicate early morning, late afternoon and evening, but you will use a higher frequency to cover the same distance during times when the sun is high in the sky (for example, midday). You will need to observe the above rule carefully if your Transceiver has a limited number of frequencies programmed into it, as you may only be able to communicate effectively at certain times of the day.

Weather Conditions

Certain weather conditions will also affect HF / SSB communications. Stormy conditions will increase the background noise as a result of static caused by lightning. This background noise could rise to a level that will blank out the signals you are trying to receive.

Man-made Electrical Interference

Interference of an electrical nature can be caused by overhanging power lines, high power generators, air-conditioners, thermostats, refrigerators and vehicle engines, when in close proximity to your antenna. The result of such interference may cause a continuous or intermittent increase in the level of background noise.

System Configuration and Installation

The method in which your system is configured and installed will also affect the success of your HF / SSB communications. Your choice of antenna system and power supply is critical. Correct installation is also extremely important. An HF / SSB Transceiver is generally installed using different rules to those used to install VHF or UHF Transceivers. Failure to correctly install an HF / SSB system will greatly affect the communications quality you will obtain.

Your local Barrett representative will be able to assist with your system configuration and / or installation.

HF Communications Compared with VHF or UHF Short Distance Communications

Communications on any HF / SSB Transceiver will sound different to that on a VHF (Very High Frequency) radio or UHF (Ultra High Frequency) radio or telephone. This is because of the nature of HF propagation and the modulation methods used. On HF / SSB Transceivers there will always be background noise evident behind the signal you are receiving and this will increase when there is electrical interference or thunderstorm activity in the area.

Compliance

Barrett 4000 series Transceivers comply to the following communications standards:

- Australian / New Zealand Standard
- MF and HF Radio Communications.

Equipment in the land mobile service utilising single sideband suppressed carrier emission:

- AS/NZS 4770:2000
- FCC Part 90.

Barrett 4000 series Transceivers comply to the following EMC standard:

- EN301 489-1 V 1.4.1 (2002-08).

Barrett 4000 series Transceivers comply to the following electrical safety standard:

- EN60950-1:2002.

FCC RF Exposure Compliance Statement

The Barrett 4000 Series Transceivers have been evaluated and comply with the Federal Communications Commission (FCC) RF exposure limits for the General Population/Uncontrolled exposure environment.

In addition, the Transceivers comply with the following standards and guidelines:

- FCC 96-326, Guidelines for Evaluating the Environmental Effects of Radio-Frequency Radiation
- FCC OET Bulletin 65 Edition 01-01 (2001) Supplement C, Evaluating Compliance with FCC
- Guidelines for Human Exposure to Radio Frequency Electromagnetic Fields
- ANSI/IEEE C95.1-1992, IEEE Standard for Safety Levels with Respect to Human Exposure to Radio Frequency Electromagnetic Fields, 3 kHz to 300 GHz
- ANSI/IEEE C95.3-1992, IEEE Recommended Practice for the Measurement of Potentially Hazardous Electromagnetic Fields - RF and Microwave.

RF Exposure Warning

To ensure optimal Transceiver performance and to avoid exposure to excessive electromagnetic fields, the antenna system must be installed according to the instructions provided.

High voltages exist on the antenna during transmission and tuning. Do not touch the antenna during these activities. RF burns may result.

Install the grounding system or counterpoise as directed to prevent RF burns from any metal part of the Transceiver.



For IC and FCC compliance, when the 4050 Transceiver is used at a power level of 150 watts PEP and a 13 dBi gain antenna, the antenna(s) used with this Transceiver should be located at least 6 metres from the operator and should not be co-located or operating in conjunction with any other antenna or transmitter.



For IC and FCC compliance, when the 4050 Transceiver is used in a vehicular environment at a power level of 150 watts PEP with 1.5 dBi gain antenna, the antenna(s) used with this Transceiver should be located at least 1.6 metres from the operator and should not be co-located or operating in conjunction with any other antenna or transmitter.

Typical antenna types and minimum separation distance:

Antenna type	Gain (dBi)	PEP (W)	Minimum safe separation distance (m)	Typical environment
Automatic tuned and Whip	0	150	1.3	Vehicle
Magnetic Loop	1.5	150	1.6	Vehicle
Multi-wire Broadband	5	150	2.4	Fixed
Log-Periodic	13	150	5.9	Fixed
Automatic tuned and Whip	0	100	1.1	Vehicle
Magnetic Loop	1.5	100	1.3	Vehicle
Multi-wire Broadband	5	100	1.9	Fixed
Log-Periodic	13	100	4.8	Fixed
Automatic tuned and Whip	0	30	0.6	Vehicle
Magnetic Loop	1.5	30	0.7	Vehicle
Multi-wire Broadband	5	30	1.1	Fixed
Log-Periodic	13	30	2.7	Fixed

The above antennas are identified for reference only. It is important that the installer and operator maintain a minimum safe separation distance with the actual antenna used in the installation and to insure, in a vehicular environment, that the transmitter is only used when persons outside the vehicle are at least the recommended lateral distance away.

The image below shows an example of minimum recommended separation distance from antenna in a vehicular environment.

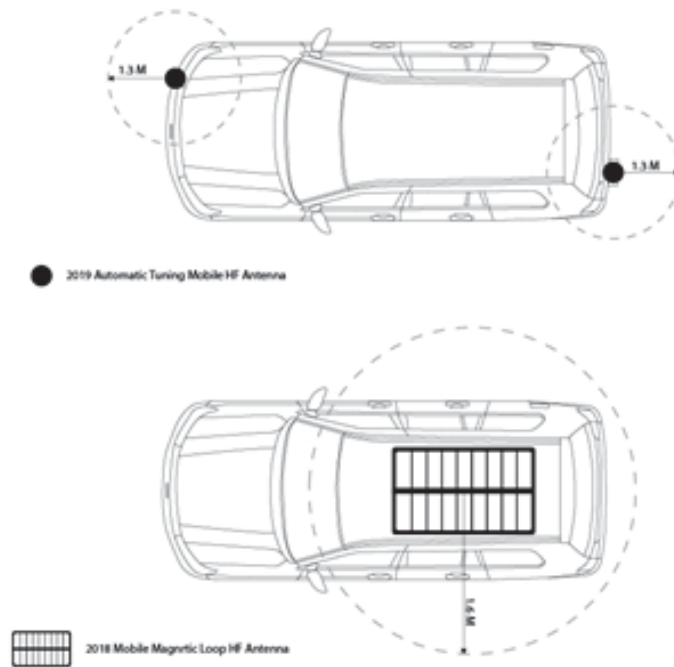

Note: If the minimum safe distance for occupants of the vehicle cannot be maintained due to the physical location of the antennas it is recommended that reduced transmit power (30W) is used.

Limited 3 Year Warranty Statement

Barrett Communications Pty Ltd provides a maximum three year warranty on all equipment it manufactures which is to be used expressly for high frequency, single sideband radio communications. This warranty covers faults arising from defects in design, workmanship or materials. Please note that this warranty does not cover batteries.

Should any fault due to bad design, workmanship or materials be proven at any time within the warranty period, the company will rectify such fault free of charge providing the equipment is returned freight paid to Barrett Communications Pty Ltd head office or to an authorised service centre. The warranty period for all products is thirty six (36) months after date of shipment from the factory.

In the event that Barrett Communications repairs or replaces a defective product part under warranty, the repaired or replaced product will remain covered under and throughout the term of the original warranty period up to its expiration. No repair or replacement will extend the warranty term past the original thirty six (36) month anniversary of the original shipment delivery date of the Barrett Product.

This warranty shall not cover any abuse, accident, improper installation, connection, adjustment or use other than in accordance with the instructions issued by the company.

In addition, this warranty shall not cover the distance which transceiver products will operate over or quality of transmission or reception as a result of unfavourable environmental conditions. Nor shall this warranty cover the quality of transmission and reception of transceivers mounted in vehicles or vessels that have not been sufficiently electrically suppressed.

Subject to the matters set out in this warranty, no liability, expressed or implied is accepted for any consequential loss, damage or injury arising as a result of a fault in the equipment and, all expressed or implied warranties as to quality or fitness for any purpose are hereby excluded.

This warranty does not extend to products supplied by the company which are not designed or manufactured by it. Barrett Communications Pty Ltd will however make every endeavour to ensure that the purchaser receives full benefit on any warranty given by the original equipment manufacturer.

This warranty is restricted to the original purchaser. Where the original purchaser is a reseller who has purchased for the purpose of resale, warranty shall be extended to the reseller's customer.

Warranty Registration and Technical Support

Thank you for purchasing Barrett HF communications products.

Please complete the warranty registration form on the next page and send it to us by mail, fax or email. Please see contact details below.

Once received your contact details will be registered against the serial numbers of your equipment and Barrett Communications will then be able to contact you if needed to keep you informed of any developments relating to your equipment.

If you have access to the Internet you can use the warranty registration page in the tech support section of our website to register your warranty form. Please go to www.barrettcommunications.com.au/Support.html

Barrett Communications is proud of its reputation for support of its customers. This registration process has been introduced so that we may continue to improve our level of support to you.

Warranty Registration Contact Details

By Mail The registration forms can be returned by mail, (no postage stamp required in Australia)

Facsimile 08 9418 6757 (International +618 9418 6757)

Email support@barrettcommunications.com.au

Our customer / dealer technical support department can be contacted via land mail, email, telephone or with the support department contact form on the tech support web page.

Barrett Communications Pty Ltd Head Office:

PO Box 1214, Bibra Lake WA 6965 AUSTRALIA

Toll Free Tel: 1800 999 580 (Within Australia)

Tel: +618 9434 1700

Fax: +618 9418 6757

email: support@barrettcommunications.com.au

Telephone support from the Australian support office is available from 7:30 am to 4:30 pm local time Monday to Friday.

Barrett Communications – Europe:

Unit 9, Fulcrum 2 Victory Park, Solent Way,
Whiteley Hampshire PO15 7FN United Kingdom

Tel: +44 (0) 1489 880 332

Fax: +44 (0) 1489 565 422

email: support@barrettcommunications.co.uk

Telephone support from the UK support office is available from 8:30 am to 5:00 pm local time Monday to Friday.

Index

A

- AGC Hang 95
- Alarm Audio Level 87
- ALE 100
 - 3G Address 110
 - 3G Alias 70
 - 3G Channels 110
 - Alias 70
 - Channel 64
 - Enable/Disable 113
 - Save Settings 110
 - Settings 101
 - State 102
- Antenna
 - 911 Automatic Antenna Tuner 173
 - Connection Details (Base Station) 176
 - Connection Details (Marine) 201
 - 912 Multi wire Broadband Dipoles 165
 - 912 Single Wire Broadband Dipoles 162
 - 913 Series Helical Dipoles 167
 - 914 Series Manual Tap Whip 193
 - Connection Details 196
 - 915 Wire Dipole 169
 - 2018 Mobile Magnetic Loop 197
 - Connection Details 197
 - 2019 Automatic Tuning Mobile Antenna 186
 - Assembly 189
 - Connection Details (Mobile Pack) 191
 - Mounting 186
 - 4011 Automatic Antenna Tuner for Base Station 177
 - Connection Details 178
 - 4017 Automatic Tuning Horizontal Dipole 171

- Connection Details 172
 - Interference Suppression Kit 183
 - Noise Suppression 182
 - Socket 64, 75
 - Type 98
- ARINC, Enable/Disable 113
- ATU Connector 151
- Audio 86
 - Mute 137
- Audio Bandwidth 89
- Audio in Tx 78
- Audio Level Alarm 87
- Audio Record 91
- Audio Scrambler 56
- Auxiliary Connector 149

B

- Backlight Level 116
- Backlight Timeout 116
- Baud Rate 97
- Beacon Call 32
 - Receive 32
 - Send 32
- Beep Level 87
- BER Threshold 107
- BITE Test 54
- BoB 123
 - Name 123
 - Network Settings 124
 - Network Status 127
- Bonjour 139
- Broadcast Filter 95

C

- Call History 47
- Calling Groups 34

BARRETT 4050 HF SDR TRANSCEIVER - OPERATING AND INSTALLATION MANUAL

- Call Key 31
 - Call Type 31
 - Channel 60, 130
 - Add a Channel 61
 - ALE Channel 64
 - Antenna Socket 64
 - Delete a Channel 66
 - Edit a Channel 65
 - Label 59
 - Mode 63
 - Number 62
 - Rx Frequency 62
 - Save Channel 65
 - Search a Channel 131
 - Selcall Format 64
 - Select Channel 131
 - Tx Frequency 63
 - Tx Power 63
 - Clarify Range 94
 - Connectors 148
 - ATU 151
 - Auxiliary 149
 - Control Head 149
 - Control Head Rear Panel 152
 - GPS 148
 - Microphone 151
 - Power 148
 - Contacts 45, 66
 - Add 67
 - Delete Contact 72
 - Edit Contact 71
 - Search Contacts 67
 - Sort Contacts 66
 - Contacts screen 66
 - Control Head Connector 149
 - Control Head Rear Panel Connector 152
 - Cooling Fan 147
 - Connector 152
- D**
- Data Link Timeout 108
 - Date and Time 53
 - Digital Voice 138
 - Enable/Disable 113
 - Display 22, 115
 - Backlight Level 116
 - Backlight Timeout 116
 - Language 54
 - Timeout Behaviour 116
 - Dwell Time 73
- E**
- Email Address 70
 - Emergency Calls 26
 - Export 114
 - EXT Alarm Type 97
- F**
- Favourite 46
 - Add 71
 - Frequency Hopping, Enable/Disable 113
 - Front Panel 15
 - Front Panel Rear View 16
- G**
- General Configurations screen 52
 - General Menu 52
 - GPS Broadcast 84
 - GPS Connector 148
 - GPS Pos 41
 - GPS Req 40

BARRETT 4050 HF SDR TRANSCEIVER - OPERATING AND INSTALLATION MANUAL

- Group Calls
 - Calling Groups 31
 - Receiving Groups 34

H

- Hangup 42
- Hop 132
- Hopping PIN 55
- Hop Rate
 - Frequency 56
 - Secure Calls 58

I

- Import Configuration 128
- Import / Update 127
- Installation 156
 - Land Based 159
 - Fixed Station 160
 - Mobile 180
 - Marine 198
- Interference Suppression Kit 183
- International Selcall ID 79
- IO 96

K

- Keypad 16

L

- Labels 59
- Label screen 62
- Language 54
- Last Number Redial 37
- Line Audio 90
- Line Follows Digital Voice 90
- Line In Level 91
- Line Out Level 91
- Lock 85

- Locking the Screen 21
- LQA Averaging 105
- LQA Decay Rate 105
- LQA Exchange 104
- LSU Mode 109

M

- Menu Map 50
- Menus 49
- Meter Mode
 - Receive 117
 - Transmit 117
- Microphone 24
 - Transmit Timeout 93
 - Tx Over Beep 53
 - Up / Down Keys 53
- Microphone Connector 151
- Mobile Pack 156
- Mode 63, 134
 - Mode screen 63
- Mute 137
 - Attributes 77
 - Audio 137
 - Signal Strength Level 77, 137
 - Syllabic Sensitivity 77, 137

N

- Network 118
 - Network Selcall ID screen 79
 - Selcall Networks 81
- Noise Blanker 94, 138
- Noise Suppression 182
- NR 135

O

- OEM 1 Calls 30

BARRETT 4050 HF SDR TRANSCEIVER - OPERATING AND INSTALLATION MANUAL

- OEM Privacy Key 80
- OEM Secure Key 56
- OEM Secure Type 56
- OEM Selcall ID 80
- Option PINs 113
- P**
- Pagecall 38
 - Receive 39
 - Send 38
- Power Connector 148
- Preamble Time 79
- Preselector 95
- Preset Map 102
- Program Firmware 129
- Programming 25
- R**
- Rear Panel 17
- Receive Meter Mode 117
- Response Control 103
- Resume Time 73
- Resync 21
- RF 92
- Ring Tones 88
- RS232 Baud Rate 97
- RS232 Out 96
- Rx Configuration 88
- Rx Preamp 92
- S**
- Scan 72, 135
 - Rate 72
 - Selcall Scan 136
 - Signal Strength Scan 136
 - Voice (Syllabic) Scan 136
- Scan Table 73
 - Add 74
 - Antenna Type 75
 - Channel List 75
 - Delete 76
 - Edit 74, 76
 - Name 75
 - Save 76
 - Select 73
- SDR Name 52
- SDR Serial Number 114
- Secure Call 44
 - Enable/Disable 113
 - Hop Rate 58
- Secure Call Codes 58
- Secure Data Key 57
- Secure Digital Voice Key 57
- Security 55
- Selcall 29, 33, 78
 - Format 82
 - ID
 - 4 Digit 82
 - 6 Digit 83
 - International Selcall ID 79
 - OEM Selcall ID 80
- Networks 81
 - Add 81
 - Alias 82
 - Delete 84
 - Edit 83
 - Save 83
- Receive 33
- Selcall Screen 78
- Send 33
- Selcall Format 64

BARRETT 4050 HF SDR TRANSCEIVER - OPERATING AND INSTALLATION MANUAL

- Selcall Format screen 64
 - Self IDs 29
 - Serial Number 114
 - Settings Menu 49
 - Settings screen 49
 - Signal Strength Level 77
 - SINAD Threshold 106
 - Software Version Information screen 112
 - Sounding Address 104
 - Sounding Control 103
 - Specifications 153
 - General 153
 - Receiver 154
 - Transmitter 155
 - Squelch 77
 - SSL 77
 - Station ID Ranges 30
 - Status Call 43
 - Swipe Menu 138
 - Syllabic Sensitivity 77
 - System Info 111
 - System Status 111
- T**
- TC2 Programming Mode 58
 - Telcall 29, 35
 - Receive 37
 - Send 35
 - Temperature Units 117
 - Threshold Test 106
 - Transceiver 15
 - Front Panel 15
 - Front Panel Rear View 16
 - Keypad 16
 - Rear Panel 17
 - Switching On / Off 18
 - Transceiver Lock 85
 - Transceiver Name 52
 - Transceiver Options 113
 - Transmit Meter Mode 117
 - Tune 134
 - Tx Configuration 89
 - Tx Over Beep 93
 - Tx Power 63
 - Tx Power Level 94
 - Tx Power screen 63
- U**
- Unlocking the Screen 21
- V**
- Version Information 112
 - Voice Link Timeout 108
 - Voice Security, Enable/Disable 113
 - Volume 19
 - VSWR 134
- W**
- WiFi
 - Access Point Mode 120
 - Access Point Setup 120
 - Client 118
 - Enable/Disable 113
 - Operation Mode 118
 - Wireless Application 139

Barrett Communications Pty Ltd
47 Discovery Drive, Bibra Lake, WA 6163 Australia
Tel: +61 8 9434 1700 Fax: +61 8 9418 6757
Email: information@barrettcommunications.com.au
www.barrettcommunications.com.au